

DOCUMENT RESUME

ED 444 003

CE 080 572

TITLE Environmental & Agricultural Systems Career Cluster ITAC for Career-Focused Education. Integrated Technical & Academic Competencies.

INSTITUTION Ohio State Univ., Columbus. Vocational Instructional Materials Lab.

SPONS AGENCY Ohio State Dept. of Education, Columbus. Div. of Career-Technical and Adult Education.

PUB DATE 1999-00-00

NOTE 108p.; For other ITAC documents, see CE 080 570-577.

AVAILABLE FROM Publications, Center on Education and Training for Employment, 1900 Kenny Road, Columbus, OH 43210-1090, Tel: 800-848-4815, ext. 24277, Fax: 614-292-1260, Web site: <http://www.cete.org/products> (ITAC Cluster-E/A, \$20).

PUB TYPE Guides - Non-Classroom (055)

EDRS PRICE MF01/PC05 Plus Postage.

DESCRIPTORS Academic Education; *Agricultural Education; Agricultural Occupations; Behavioral Objectives; Career Development; *Career Education; Career Planning; Communication Skills; Competence; *Competency Based Education; Core Curriculum; Critical Thinking; Education Work Relationship; Employment Qualifications; *Environmental Education; Evaluation Criteria; Integrated Curriculum; Job Skills; Learning Activities; Money Management; Occupational Clusters; Partnerships in Education; Performance Factors; Problem Solving; Relevance (Education); School Business Relationship; Secondary Education; Skill Development; Skilled Occupations; *Statewide Planning; Student Evaluation; Systems Approach; Teaching Guides; Technical Education; Technical Occupations; Thinking Skills; Time Management; Transfer of Training; *Vocational Education; Wellness; Work Attitudes

IDENTIFIERS Contextualized Instruction; *Ohio; Work Keys (ACT)

ABSTRACT

Designed for Ohio educators responsible for planning programs to prepare high school students for careers in environmental and agricultural systems, this document presents an overview of Ohio's Integrated Technical and Academic Competencies (ITAC) system of career-focused education and specific information about the environmental and agricultural systems ITAC career cluster. The first half of the document, which introduces the ITAC system's underlying principles and elements, contains the following items: (1) descriptions of the three types of integrated competencies (core, career cluster, and specialization) forming the ITAC model; (2) guidelines for using ITAC; (3) an explanation of the components of the 51 core ITAC; and (4) a table detailing the academic connections in the core ITAC. The second half of the document, which focuses on the environmental and agricultural systems career cluster ITAC, is divided into six sections, each of which focuses on one of the following strands deemed essential for all careers: solving problems and thinking skillfully; communicating effectively; applying technology; working responsibly; planning and managing a career; and managing resources. Each section contains the following items: expectation; competencies; sample scenario; sample guiding questions; connections to core

Reproductions supplied by EDRS are the best that can be made
from the original document.

ITAC competencies; connections to academic models; and connections to Ohio's proficiency tests and ACT Work Keys. (MN)

Reproductions supplied by EDRS are the best that can be made
from the original document.

ED 444 003

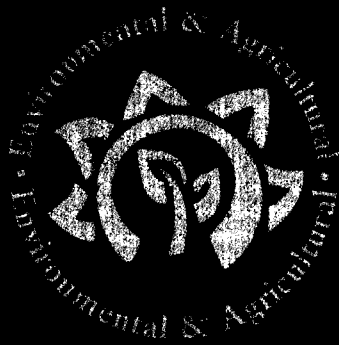

Environmental & Agricultural Systems Career Cluster ITAC for Career-Focused Education

PERMISSION TO REPRODUCE AND
DISSEMINATE THIS MATERIAL HAS
BEEN GRANTED BY

C. Hansen

TO THE EDUCATIONAL RESOURCES
INFORMATION CENTER (ERIC)

1

U.S. DEPARTMENT OF EDUCATION
Office of Educational Research and Improvement
EDUCATIONAL RESOURCES INFORMATION
CENTER (ERIC)

- This document has been reproduced as received from the person or organization originating it.
- Minor changes have been made to improve reproduction quality.
- Points of view or opinions stated in this document do not necessarily represent official OERI position or policy.



ITAC

BEST COPY AVAILABLE

Integrated Technical & Academic Competencies

CE080512



Environmental & Agricultural Systems



















Career Cluster ITAC

The Environmental & Agricultural Systems Career Cluster includes the entry-level, technical and professional career options within environmental and agricultural industries. This career cluster includes service, research, education, and production types of careers. Numerous career opportunities exist in agricultural sales and services, animal and crop production, education, engineering and mechanical systems, food processing, horticulture, and natural resources.

Sample career options within this cluster include—

- veterinarian
- pork producer
- wildlife biologist
- park ranger
- floral designer
- landscape architect
- biosystems engineer
- animal groomer
- extension agent
- foods inspector
- golf course supervisor
- water quality technician
- animal nutritionist
- feed, fertilizer, and equipment salesperson

Contents

	PAGE
Career-Focused Education	3
Components of the ITAC System	4
How to Use ITACs	5
Components of Core ITAC	6
 Strand 1: Solving Problems and Thinking Skillfully	9
 Strand 2: Communicating Effectively	15
 Strand 3: Applying Technology	21
 Strand 4: Working Responsibly	25
 Strand 5: Planning and Managing a Career	29
 Strand 6: Managing Resources	35
Academic Connections in Core ITAC	41
     	
<small>The Arts Math Social Studies Language Arts Foreign Language Science</small>	
Core ITAC Acknowledgments	45
Environmental & Agricultural Systems Career Cluster Title Page	47
Components of Career Cluster ITACs	48
Environmental & Agricultural Systems Career Cluster ITAC Document	
 Strand 1: Solving Problems and Thinking Skillfully	51
 Strand 2: Communicating Effectively	63
 Strand 3: Applying Technology	69
 Strand 4: Working Responsibly	77
 Strand 5: Planning and Managing a Career	83
 Strand 6: Managing Resources	89
Environmental & Agricultural Systems Career Cluster ITAC Acknowledgments	102

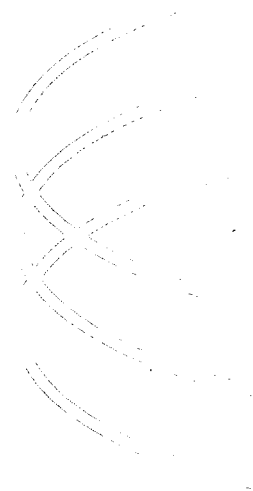
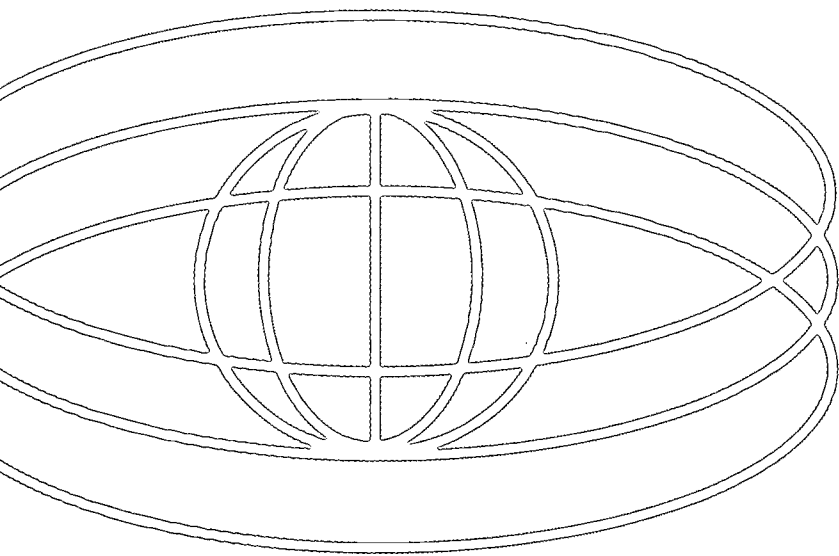

Career-Focused Education

Career-Focused Education combines high-level academics and technical skills with a real-life context for learning that maximizes students' present and future academic and career success. Career-focused education strengthens—

- proficiency test success
- integrated instruction
- partnerships between education and business & industry
- aquisition of transferable career skills

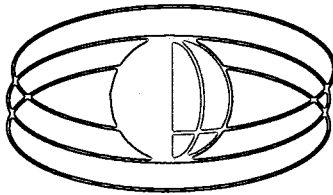

ITAC

Integrated Technical &
Academic Competencies
for Career-Focused Education

Ohio Department of Education
Division of Career-Technical and Adult Education
© 1999 by the Vocational Instructional Materials Laboratory
Vocational Instructional Materials Laboratory
Center on Education and Training for Employment • The Ohio State University
1900 Kenny Road • Columbus, Ohio 43210
1-800-848-4815 • www.cete.org/products

Components of the ITAC System

Integrated Technical and Academic Competencies (ITAC) documents consist of competencies that integrate academic, technical, and employability knowledge, skills, and attitudes. ITACs are presented in resource documents that include the expectations, competencies, scenarios, and academic connections. ITACs are developed through—

- review and synthesis of national academic, employability, and occupational standards;
- review by teachers—both vocational and academic;
- validation by business and industry representatives; and
- direct links to Ohio’s competency-based education (CBE) models, proficiency test learning outcomes, and ACT Work Keys® System.

ITAC Model

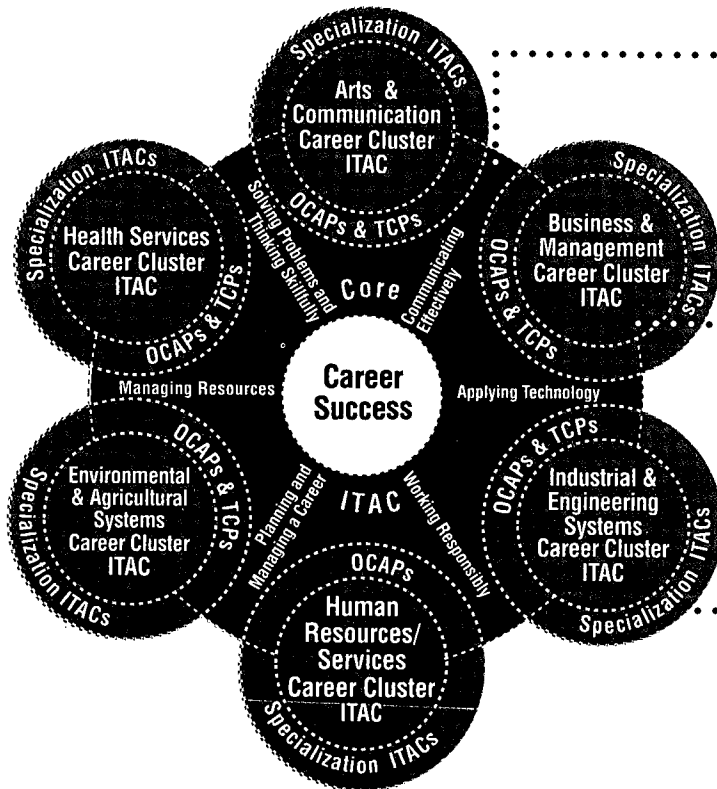

Three types of ITACs form this model:

- **Core ITAC** – Consists of 51 competencies organized into six strands essential for all careers and sample work-related scenarios. Core ITAC represents what individuals need to know and be able to do to be successful in further education, in a career, and in life.
- **Career Cluster ITAC** – Consists of the foundational competencies common to related occupations or industries and sample work-related scenarios. The six Career Cluster ITACs provide a broad foundation for entry-level, technical, and professional careers.
- **Specialization ITAC** – Consists of competencies and sample scenarios critical to success in a specific industry or occupation within a career cluster. Currently, 55 Occupational Competency Analysis Profiles (OCAPs) represent the Specialization Competencies. As OCAPs are revised, they will become Specialization ITACs.

The ITAC system builds on and expands the Occupational Competency Analysis Profile (OCAP) system, which was designed primarily for occupation-specific vocational programs. The ITAC system provides a broader range of competencies, integrates academic knowledge and skills with technical content, and provides sample scenarios to illustrate work-related context. This system is a resource for **both** academic and technical teachers as they plan programs and instruction.

How to Use ITACs

Integrated Technical and Academic Competencies (ITAC) documents are resources for planning programs. The competencies of the ITAC system integrate technical and academic content and are organized into three types, moving from broad to specific—core, career cluster, and specialization. The types are interrelated building blocks for program design. *Core* provides the broad competencies. *Career Cluster* incorporates use of *Core* competencies. *Specialization* incorporates application of both the related *Career Cluster* and *Core* competencies. These ITAC types can be integrated into the overall educational system as follows:

- The Core ITAC could be used to design learning experiences for all students.
- The Career Cluster ITACs—in combination with Core ITAC—could be used to guide courses or experiences in which students explore and develop essential competencies within one of the following career clusters:
 - ✓ **Arts & Communication**
 - ✓ **Business & Management**
 - ✓ **Environmental & Agricultural Systems**
 - ✓ **Health Services**
 - ✓ **Human Resources/Services**
 - ✓ **Industrial & Engineering Systems**
- Specialization ITACs—in combination with Core ITAC and Cluster ITACs—could be used for those programs, courses, and experiences with specific technical skill development.

As a curricular and instructional planning tool, ITACs identify the knowledge, skills, and attitudes needed to help students prepare for academic and career success. ITAC documents foster the development of interdisciplinary projects and learning experiences by illustrating the relationships between broad-based career skills and academic content. Educators can use the components of the ITACs in a number of ways for classroom instruction:

- Competencies can be reviewed and relevant competencies selected for instruction.
- Connections that need to be made between competencies and academic skills can be identified.
- Scenarios can be used as a basis for learning experiences.

Components of Core ITAC

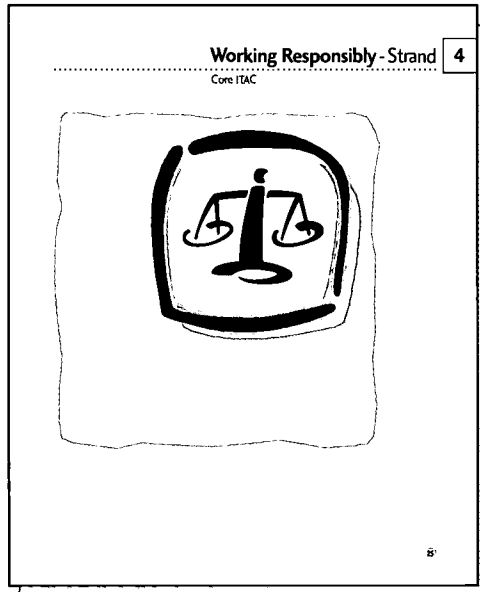

• Each strand in Core ITAC has an introduction page which identifies the strand (in words and by icon).

• • • **Expectation** – a statement of desired workplace behaviors and their importance in the world of work.

Competencies – observable and measurable knowledge, skills, and attitudes essential to achievement of the expectation.

 Strand 4 – Working Responsibly – Core ITAC

Expectation

Work organizations value employees who possess the ability to work with diverse groups of people and who are able to lead others toward the achievement of common goals. Individuals must demonstrate a positive work ethic—exhibiting honesty, initiative, and dependability. In addition, they should understand the importance of ethical conduct and the role of ethics in professional organizations and work environments.

Competencies

4.1 Demonstrate leadership	4.5 Comply with the confidentiality requirements of workplace policies and procedures
4.2 Contribute to teamwork	4.6 Apply appropriate strategies for dealing with the differences associated with diversity (e.g., racial, ethnic, gender, educational, personality, social, and age)
4.3 Choose ethical courses of action in all work assignments and personal interactions	
4.4 Demonstrate the work ethic	

Scenario

You are the director of human resources for a chain of retail stores. Lately there have been several incidents in which employees have treated customers rudely or unfairly because of the customers' racial or ethnic background. You have been asked to provide training for employees that will encourage an appreciation of diversity, positive relations with customers, and an understanding of the legal and economic implications of inappropriate behavior. Present the training plan to your company's management team for their approval.

Guiding Questions

- What are the benefits of multicultural diversity? What can business organizations do to support an appreciation of diversity?
- What are the contributions of various ethnic groups to businesses, communities, and society?
- What are the legal, social, and economic consequences of prejudicial or discriminatory actions for individuals, businesses, and communities?
- What laws prohibit discriminatory actions? In what context were these laws enacted?

• • • **Sample Scenario** – a real-life workplace situation requiring learners to apply the knowledge and skills reflected in the strand competencies.

Sample Guiding Questions – targeted questions to use in focusing learners' attention on knowledge and skills covered in the scenario.



Solving Problems and Thinking Skillfully

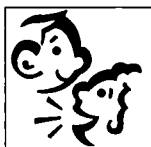

Communicating Effectively



Applying Technology



Working Responsibly



Planning and Managing a Career



Managing Resources

BEST COPY AVAILABLE

Core ITAC – Working Responsibly – Strand 4



- 4.1 Demonstrate leadership**
- Key Indicators:
- 4.1.1 Identify a variety of leadership strategies
 - 4.1.2 Demonstrate leadership qualities
 - 4.1.3 Distinguish between the uses of leadership and management
 - 4.1.4 Analyze the factors influencing choice of leadership strategy in a given situation
 - 4.1.5 Match leadership strategies to the given group situation
 - 4.1.6 Collaborate with others to accomplish goals
- 4.2 Contribute to teamwork**
- Key Indicators:
- 4.2.1 Demonstrate sensitivity to cultural, gender, and generational differences (in communication, interpersonal skills, and learning preferences)
 - 4.2.2 Demonstrate concern for each team member and for team goals (e.g., provide encouragement, maintain a can-do attitude and common focus)
 - 4.2.3 Complete aspects of assigned tasks according to team-established procedures and within specific timelines
 - 4.2.4 Employ group process techniques to solve problems, make decisions, build consensus, resolve or manage conflicts, construct compromises, support self-expression, and bring forth new ideas and opinions
 - 4.2.5 Evaluate the team's efforts
- 4.3 Choose ethical courses of action in all work assignments and personal interactions**
- Key Indicators:
- 4.3.1 Establish a personal code of ethics
 - 4.3.2 Ensure that personal code of ethics is consistent with the professional code of ethics of the chosen profession
 - 4.3.3 Identify strategies that strengthen desirable character traits (including honesty, integrity, compassion, empathy, justice)
 - 4.3.4 Identify consequences of unethical conduct
 - 4.3.5 Recognize conflict between personal/professional ethics and the ethics of others
 - 4.3.6 Demonstrate awareness of legal responsibilities (e.g., copyright laws, harassment, equity)
 - 4.3.7 Identify strategies for responding to the unethical actions of individuals and organizations

Pages following the overview list each competency with its key indicators. Key indicators describe significant elements of competency performance.

BEST COPY AVAILABLE

Integrated Technical & Academic Competencies – ITAC

Core ITAC Competencies	Academic Models					
	Percent of Model Relating to Core ITAC					
	The Arts	Math	Social Studies	Language Arts	Foreign Language	Science
Strand 3 – Applying Technology						
3.1 Demonstrate technological literacy	5%	1%	1%	0%	0%	8%
3.2 Access/retrieve information using electronic communication systems	+1%	0%	0%	2%	11%	3%
3.3 Demonstrate computer literacy	4%	2%	0%	4%	3%	4%
3.4 Use database software in work-related situations	0%	0%	0%	+1%	0%	3%
3.5 Use spreadsheet software in work-related situations	0%	+1%	0%	0%	0%	2%
3.6 Use word processing software in work-related situations	+1%	0%	0%	2%	2%	3%
Strand 4 – Working Responsibly						
4.1 Demonstrate leadership	0%	0%	2%	1%	0%	4%
4.2 Contribute to teamwork	20%	0%	5%	23%	4%	5%
4.3 Choose ethical courses of action in all work assignments and personal interactions	0%	0%	+1%	1%	0%	4%
4.4 Demonstrate the work ethic	+1%	0%	1%	13%	3%	4%
4.5 Comply with the confidentiality requirements of workplace policies and procedures	0%	0%	0%	+1%	0%	1%
4.6 Apply appropriate strategies for dealing with the differences associated with diversity (e.g. racial, ethnic, gender, educational, personality, social, and age)	20%	0%	8%	20%	8%	4%
Strand 5 – Planning and Managing a Career						
5.1 Identify how personal interests, abilities, and skills relate to choosing a career	8%	0%	1%	11%	2%	1%
5.2 Investigate career options	6%	0%	0%	+1%	3%	1%
5.3 Chart career using career-planning skills	2%	0%	0%	+1%	2%	1%
5.4 Demonstrate skills needed to enter or reenter the workforce	4%	0%	+1%	1%	5%	+1%
5.5 Demonstrate job-seeking skills	0%	0%	0%	8%	+1%	0%
5.6 Upgrade career skills	0%	0%	0%	0%	0%	0%
5.7 Explore opportunities to create businesses	2%	0%	3%	0%	1%	0%

Connections to Academic Models

– the percentage of objectives from Ohio's Competency-Based Education Models, grades PreK – 12, that relate to and/or reinforce the competencies in the given strand. Each academic area is represented by an icon.



The Arts



Mathematics



Social Studies



Language Arts

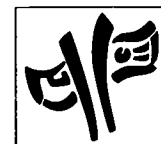

Foreign Language



Science

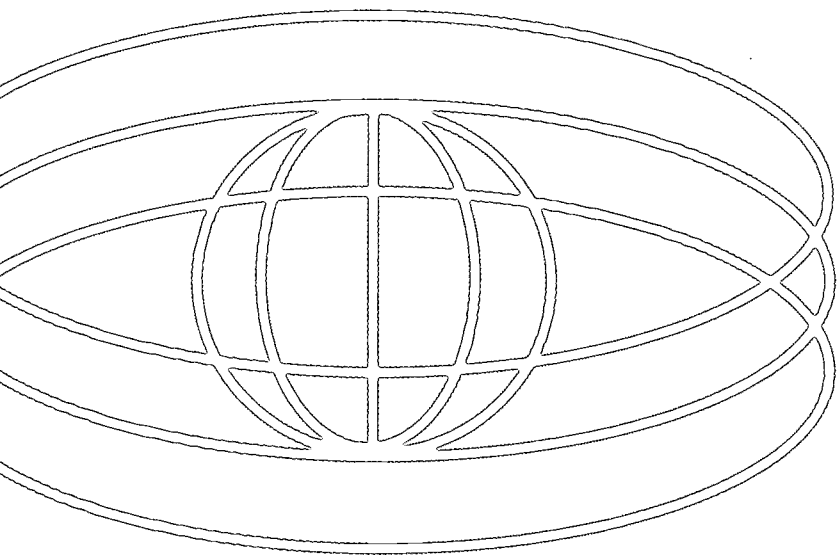

Solving Problems and Thinking Skillfully - Strand

1

Core ITAC

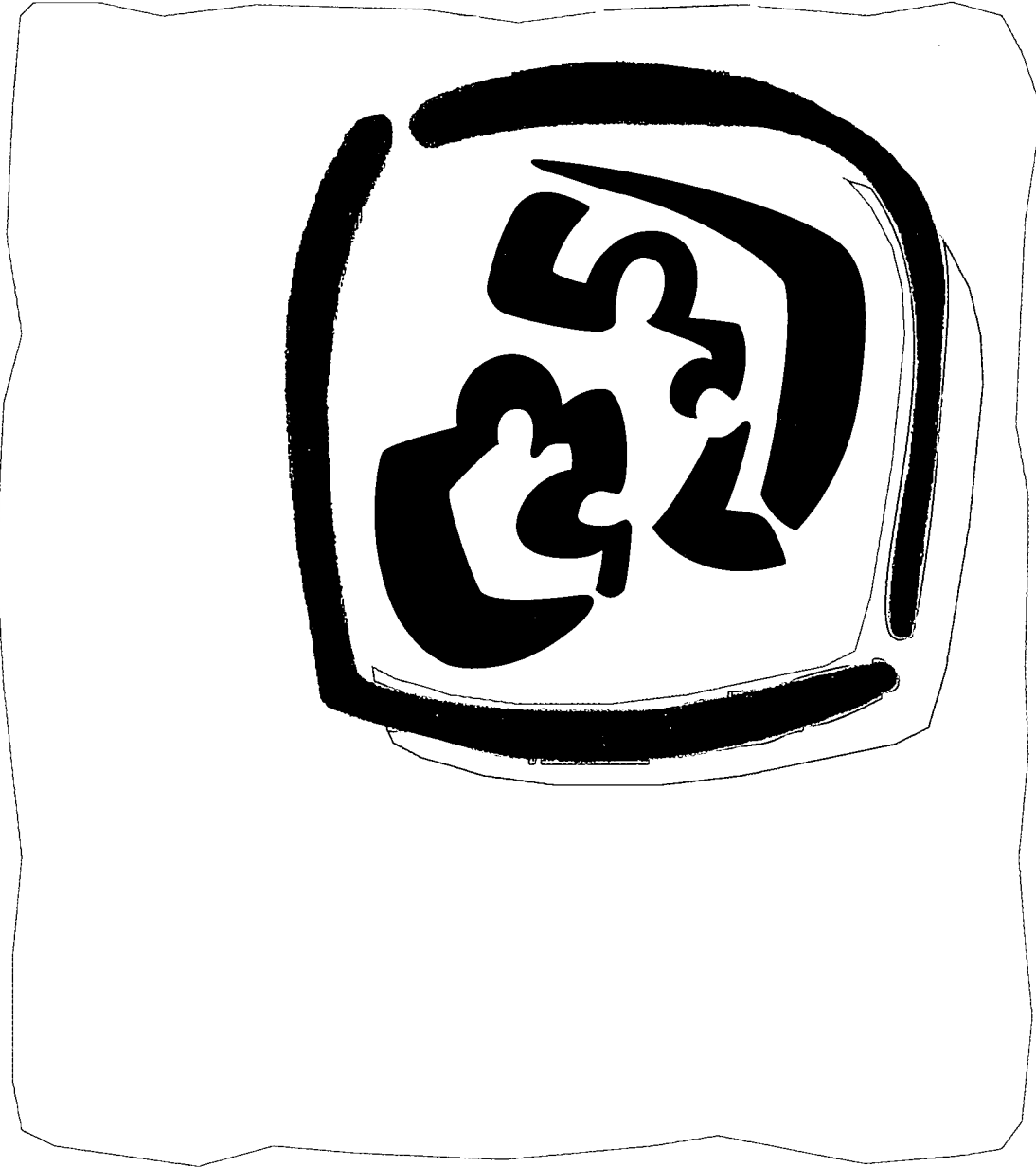



Expectation

All individuals, regardless of career choice, must be able to think for themselves; initiate action on their own; and direct, modify, and assess their own work. Employers seek lifelong learners who can locate and use information. The following competencies specify the knowledge, skills, and attitudes needed to develop the capacity to assess problems and situations, anticipate what might happen next, and continuously search for creative solutions.

Competencies

- | | | | |
|-----|--|------|---|
| 1.1 | Solve problems and make decisions in work-related situations | 1.8 | Utilize scheduling techniques to ensure that jobs are completed by the stated due date |
| 1.2 | Read for information and understanding | 1.9 | Demonstrate knowledge of the economy and how it functions as a whole |
| 1.3 | Use observation skills to analyze work-related situations | 1.10 | Demonstrate knowledge of the economy as a framework within which decisions are made by individuals and groups |
| 1.4 | Apply mathematical processes | | |
| 1.5 | Apply measurement and spatial skills | | |
| 1.6 | Apply statistical analysis skills | | |
| 1.7 | Analyze critical data to guide work activities | | |

Scenario

You are among a team of architects hired to plan the revitalization of a deteriorating historic area in your community. In spite of a rich ethnic history and residents who are committed to seeing the area thrive, the neighborhood is plagued by inadequate housing, abandoned buildings, lack of transportation, crime, and declining businesses. The City Planning Commission is prepared to provide resources to encourage economic development, recreation areas, and better housing. Create a design for the neighborhood and present your plans to the commission for their approval.

Guiding Questions

- What alternative uses should be considered for the land to best meet the needs of the community and its citizens?
- What historic and current economic, social, and environmental factors should be considered in the creation of the plan?
- What data regarding the needs and concerns of citizens and businesses in the community would inform the design of the neighborhood? How should this data be collected, analyzed, and presented?



1.1

Solve problems and make decisions in work-related situations

- 1.1.1
- 1.1.2
- 1.1.3
- 1.1.4
- 1.1.5
- 1.1.6
- 1.1.7
- 1.1.8
- 1.1.9
- 1.1.10
- 1.1.11
- 1.1.12

Key Indicators:

- Identify factors that influence problem solving and decision making
- Analyze the source of the problem or the situation requiring a decision
- Generate possible alternatives
- Analyze possible alternatives
- Match problem-solving and decision-making processes to the situation
- Use creative thinking processes to support solving problems and making decisions
- Justify solution or decision with evidence to support or refute alternatives
- Formulate action plans
- Implement action plans
- Evaluate action taken
- Monitor action plans
- Adjust action plans as needed

1.2

Read for information and understanding

- 1.2.1
- 1.2.2
- 1.2.3
- 1.2.4
- 1.2.5

Key Indicators:

- Locate needed information in written materials using formatting cues, skimming, and scanning
- Interpret written information, including manuals, graphs, and schedules
- Unlock the meaning of unknown or technical vocabulary using standard strategies (e.g., context clues, prefixes, suffixes)
- Locate key points, main ideas, relevant details, facts, and specifications in written materials
- Judge the accuracy, appropriateness, style, and plausibility of information, proposals, or theories in materials read

1.3

Use observation skills to analyze work-related situations

- 1.3.1
- 1.3.2
- 1.3.3
- 1.3.4
- 1.3.5
- 1.3.6

Key Indicators:

- Collect data through sensory perceptions—seeing, hearing, tasting, touching, and smelling
- Identify predictable patterns and relationships in given situations
- Monitor situations for deviations
- Identify patterns and relationships that create doubt, uncertainty, difficulty, or disappointment
- Devise appropriate responses to given situations
- Apply past observations to present work-related situations



1.4

Apply mathematical processes

1.4.1

Solve mathematical problems involving whole numbers and integers

1.4.2

Solve mathematical problems involving fractions, mixed numbers, decimals, percentages, ratios, and proportions

1.4.3

Key Indicators:

Apply systematic counting techniques and algorithmic thinking to represent, analyze, and solve problems

1.4.4

Use estimates to determine reasonableness of proposed problem solutions

1.4.5

Use appropriate technology in the solution of math-related problems

1.4.6

Describe problem situations using numerical, symbolic, and graphical representations

1.4.7

Apply combinations of algebraic techniques

1.4.8

Represent problem situations with geometric models (including applying the properties of figures)

1.4.9

Express mathematical ideas orally and in writing

1.5

Apply measurement and spatial skills

1.5.1

Key Indicators:

Demonstrate knowledge of units of measurement

1.5.2

Select measurement techniques appropriate for given situation

1.5.3

Match measurement tools to measurement requirements

1.5.4

Determine degree of accuracy required for given situation

1.5.5

Analyze implications of the degree of accuracy of various measurements

1.6

Apply statistical analysis skills

1.6.1

Key Indicators:

Estimate probability using standard techniques and formulas

1.6.2

Analyze software options available for statistical analysis

1.6.3

Select software option most appropriate for given situation

1.6.4

Analyze statistical data using selected software

1.6.5

Make inferences or predictions based on data analysis

1.6.6

Represent statistical data using tables, charts, and graphs

BEST COPY AVAILABLE



1.7	Key Indicators:	Analyze critical data to guide work activities
1.7.1		Identify critical data needed
1.7.2		Determine the level of detail necessary for various situations according to prescribed procedures (including task analysis; procedural analysis; financial activities; personnel matters; customer contacts; noncompliance and violations; and/or deviations from normal operation of processes, equipment and instrumentation)
1.7.3		Ensure that documentation is complete and error-free and provides valid and reliable evidence
1.7.4		Ensure that documentation is in compliance with established procedures
1.7.5		Analyze documentation to determine appropriate actions for specific situations

1.8	Key Indicators:	Utilize scheduling techniques to ensure that jobs are completed by the stated due date
1.8.1		Develop schedules for equipment maintenance
1.8.2		Develop schedules for materials production, handling, and distribution
1.8.3		Develop meeting schedules
1.8.4		Distribute schedules to all concerned personnel
1.8.5		Implement schedules as planned
1.8.6		Make changes in schedules as appropriate

1.9	Key Indicators:	Demonstrate knowledge of the economy and how it functions as a whole
1.9.1		Analyze how individuals and societies make choices to satisfy wants with limited resources
1.9.2		Analyze how factors of production (including land, labor, capital, and entrepreneurship) are used to produce goods and services
1.9.3		Analyze how individuals and households exchange their resources for income in order to buy goods and services
1.9.4		Analyze how individuals and business firms use resources to produce goods and services to generate revenue
1.9.5		Identify the characteristics of command, market, and traditional economies
1.9.6		Analyze how all levels of government assess taxes in order to provide services

BEST COPY AVAILABLE



1.10

Demonstrate knowledge of the economy as a framework within which decisions are made by individuals and groups

1.10.1

Determine opportunity costs and trade-offs

1.10.2

Identify key individuals and groups that make economic decisions at the local, state, national, and international levels

1.10.3

Identify the important roles that local, state, national, and international governments play in a global economy

1.10.4

Characterize how government decisions affect individuals

1.10.5

Identify how geographic factors affect the political and economic systems of other countries

1.10.6

Analyze how national and international markets allocate goods and services

1.10.7

Analyze how resources, goods, and services are exchanged in national and international markets

1.10.8

Demonstrate knowledge of competition and how it affects national and international markets

1.10.9

Demonstrate knowledge of supply and demand and how it affects national and international markets

Key Indicators:

BEST COPY AVAILABLE

Communicating Effectively - Strand

2

Core ITAC

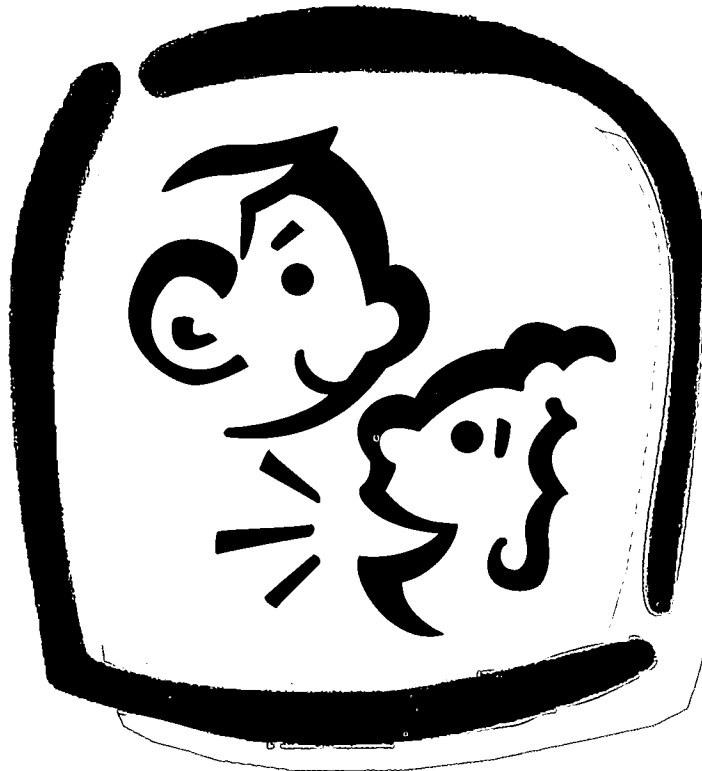



Expectation

Effective communication is essential to workplaces, communities, and families. Employees with positive communication skills contribute to organizational productivity, enhance interpersonal relationships with coworkers and clients, and create opportunities for promotion and advancement.

Competencies

2.1	Apply basic communication skills	2.7	Apply graphic communication skills
2.2	Apply oral communication skills	2.8	Apply artistic communication skills
2.3	Apply written communication skills	2.9	Convey information through multimedia presentations
2.4	Apply technical writing skills	2.10	Create graphs and charts
2.5	Apply listening skills	2.11	Build interpersonal relationships
2.6	Apply demonstration/presentation skills		

Scenario

The Chamber of Commerce in your city would like to develop materials to attract new businesses to the community. Your public relations firm has been hired to create promotional materials that highlight your community's resources, rich ethnic history, and workforce. Create these materials and present them to a variety of community members, including business and industry representatives, private citizens, and civic leaders.

Guiding Questions

- What communication tools should be used to convey this information to the target audiences?
- How will you use creative or artistic expression to communicate the information to the target audience?
- What historic and current events have contributed to the city's resources, ethnic diversity, and workforce?
- How will you work with community groups and representatives to build support for your promotional materials?



- 2.1
- 2.1.1
- 2.1.2
- 2.1.3
- 2.1.4
- 2.1.5
- 2.1.6
- 2.1.7
- 2.1.8

Key Indicators:

Apply basic communication skills

Guide communication activities using established rules for grammar, word usage, spelling, and sentence construction

Select communication style appropriate to audience and situation

Present messages in a form that assists recipient's understanding (e.g., speak and write clearly and concisely, write legibly)

Locate needed information using communications reference tools (e.g., dictionary, thesaurus, style manual, word division guide)

Interpret oral, written, and nonverbal messages

Follow written and oral instructions

Clarify messages received (e.g., through paraphrasing, questioning)

Communicate basic messages in a language other than English

- 2.2
- 2.2.1
- 2.2.2
- 2.2.3
- 2.2.4
- 2.2.5
- 2.2.6

Key Indicators:

Apply oral communication skills

Apply basic communication skills in communicating orally

Use nonverbal techniques to reinforce the intended verbal message

Support oral communication with creative attention-getters, analogies, examples, verbal illustrations, etc.

Supplement oral communication with other forms of communication (including graphic, written, artistic)

Demonstrate sensitivity to cultural diversity (e.g., accepted variations in distances between speakers, use of eye contact, meaning of gestures; bias-free language)

Adjust delivery according to perceived reception

- 2.3
- 2.3.1
- 2.3.2
- 2.3.3
- 2.3.4
- 2.3.5
- 2.3.6

Key Indicators:

Apply written communication skills

Apply basic communication skills in communicating in written form

Organize information into the appropriate format in accordance with standard practices (including prewriting, drafting, proofreading, editing/revising, preparing final copy/publishing)

Incorporate creative and original elements (e.g., unique writing style, content, layout) in the written product

Supplement written communication with other forms of communication (including graphic, oral, artistic)

Demonstrate sensitivity to cultural diversity

Use technology (e.g., spelling checkers) to enhance accuracy



2.4

Apply technical writing skills

2.4.1

Key Indicators:

Apply basic communication skills

2.4.2

Consider topic in relation to the audience and purpose

2.4.3

Determine when graphics, charts, and sketches are needed to support and clarify text

2.4.4

Present information in a clear and concise manner

2.5

Apply listening skills

2.5.1

Key Indicators:

Identify major points of the message (including key information, directions, specific details)

2.5.2

Determine real needs or goals by attending to both verbal and nonverbal messages

2.5.3

Differentiate between facts, opinions, and feelings

2.5.4

Document message using standard note-taking techniques

2.5.5

Overcome communication barriers

2.5.6

Clarify communication by rephrasing statements, asking questions, showing empathy, and interpreting both verbal and nonverbal information

2.6

Apply demonstration/presentation skills

2.6.1

Key Indicators:

Apply basic communication skills in presenting a demonstration/presentation

2.6.2

Select valid and reliable reference(s)

2.6.3

Organize content based on purpose and audience

2.6.4

Determine desirable format

2.6.5

Incorporate creative and original elements into the demonstration/presentation

2.6.6

Organize the components necessary to conduct a demonstration/presentation (including resources, equipment, handouts, graphics, advance organizers)

2.6.7

Incorporate media that support the purpose of the demonstration/presentation (including projection equipment, computer software)

2.6.8

Present the results of an investigation

2.6.9

Demonstrate the operation of equipment or facilities and/or given techniques and procedures

2.6.10

Communicate possible problems, processes, and solutions

2.6.11

Demonstrate knowledge of the topic(s) to be communicated

2.6.12

Use self-expression appropriate to the situation (including grooming, adjustment of behavior, expression of feelings and ideas)

2.6.13

Convey information to audience according to accepted business communication practices

2.6.14

Adjust communication according to audience feedback

BEST COPY AVAILABLE



2.7

Apply graphic communication skills

2.7.1

Apply basic communication skills in communicating through graphics

2.7.2

Ensure that all information is accurate and complete

2.7.3

Key Indicators: Specify graphics needed to support presentations

2.7.4

Communicate information using graphics in, print, poster, or transparency form

2.7.5

Communicate information using slides prepared with presentation software

2.7.6

Incorporate creative and original elements into graphics

2.7.7

Employ effective design techniques in development of graphics (including space, lines, shading, shaping, symbols)

2.7.8

Demonstrate sensitivity to cultural diversity

2.8

Apply artistic communication skills

2.8.1

Apply basic communication skills in communicating artistically

2.8.2

Key Indicators: Participate in a wide variety of experiences that expose self to an appreciation of the arts disciplines—dance, music, theater, and the visual arts

2.8.3

Analyze exemplary works through the relationship between artistic practices, products, and perspectives

2.8.4

Interpret historical and modern artifacts

2.8.5

Demonstrate artistic and creative techniques of production and performance

2.8.6

Create an original artifact or performance that demonstrates an understanding of history and culture

2.9

Convey information through multimedia presentations

2.9.1

Organize content based on purpose and audience

2.9.2

Key Indicators: Evaluate which set of procedures, tools, or equipment will produce the desired results

2.9.3

Produce a presentation, including designing, creating, importing data and graphics, editing, formatting, and sequencing

2.9.4

Operate multimedia equipment

2.9.5

Apply problem-solving techniques to resolve problems encountered in the process of designing and implementing multimedia presentations

BEST COPY AVAILABLE



2.10

Create graphs and charts

2.10.1

2.10.2

2.10.3

2.10.4

2.10.5

Key Indicators:

Access sources of needed information

Select data for inclusion

Convert data into chosen graphical format

Ensure that the results are correctly represented (including font, scale, size)

Draw conclusions from information presented in graphs and charts

2.11

Build interpersonal relationships

2.11.1

2.11.2

2.11.3

2.11.4

2.11.5

2.11.6

Key Indicators:

Demonstrate knowledge of the components of effective communication

Relate to people of different ages, abilities, genders, cultures, and behavior styles

Demonstrate caring, empathy, and appreciation for others

Communicate personal feelings, needs, and ideas constructively

Demonstrate effective listening skills

Manage conflict and stress

Applying Technology - Strand

3

Core ITAC





Expectation

Technology influences every work environment. To be effective in today's workplace, individuals must be able to use the tools of technology to improve productivity and efficiency. Employers seek individuals who have developed technological skills and who stay abreast of the continuously changing technological environment.

Competencies

- | | | | |
|-----|--|-----|---|
| 3.1 | Demonstrate technological literacy | 3.5 | Use spreadsheet software in work-related situations |
| 3.2 | Access/transmit information using electronic communication systems | 3.6 | Use word-processing software in work-related situations |
| 3.3 | Demonstrate computer literacy | | |
| 3.4 | Use database software in work-related situations | | |

Scenario

You own a company that sells and maintains a wide variety of office equipment and computer systems. A small, family-owned business has asked you to develop a proposal for equipping its organization with the technology necessary to improve its productivity and customer service. Prepare a proposal with your recommendations, and present it to the owners of the business to persuade them to accept your proposal.

Guiding Questions

- How have technological innovations influenced workplace performance?
- What information do you need about this business to determine its technological needs?
- How will you obtain that information?
- What hardware, software, and online services does this business need?
- What communication tools will you need to persuade this business to accept your proposal?

BEST COPY AVAILABLE



3.1

Demonstrate technological literacy

- 3.1.1 Demonstrate knowledge of the basic technology systems currently available (e.g., manufacturing technology, organizing and accessing information for technology)
- 3.1.2 Analyze the interplay of technology with social issues, gender issues, ethics, law, and government
- 3.1.3 Identify the uses of technology in industry, education, the political arena, and day-to-day consumer affairs
- 3.1.4 Analyze the benefits and costs of new developments in technology
- 3.1.5 Make decisions about the use of technology that improve performance in the workplace, in school, and in the home

Key Indicators:

3.2

Access/transmit information using electronic communication systems

- 3.2.1 Determine which systems are most appropriate for given situations
- 3.2.2 Transmit messages electronically
- 3.2.3 Access information electronically (e.g., via information services, CD-ROMs, laser disks, videos, and the Internet)
- 3.2.4 Conduct searches electronically
- 3.2.5 Participate in electronic discussion groups

Key Indicators:

3.3

Demonstrate computer literacy

- 3.3.1 Choose the hardware, software, and online services that will produce the desired results
- 3.3.2 Comply with ethical standards in the acquisition, organization, analysis, and communication of information
- 3.3.3 Keep informed of legal parameters regarding computers
- 3.3.4 Provide routine maintenance and repair of computer hardware and software
- 3.3.5 Write basic computer programs for given purposes

Key Indicators:

3.4

Use database software in work-related situations

- 3.4.1 Demonstrate knowledge of the functions and features of database software
- 3.4.2 Identify the type of data needed
- 3.4.3 Determine the best database to aid in the collection, tabulation, synthesis, and evaluation of the particular data identified
- 3.4.4 Locate needed operations information using software documentation or help functions
- 3.4.5 Construct database for the specified purpose
- 3.4.6 Access needed information from the database
- 3.4.7 Select report design for presenting data

Key Indicators:



3.5

Use spreadsheet software in work-related situations

3.5.1

Demonstrate knowledge of the functions and features of spreadsheet software

3.5.2

Identify the type of data needed

3.5.3

Determine the best spreadsheet to aid in the collection, tabulation, synthesis, and evaluation of the identified data

3.5.4

Locate needed operations information using software documentation or help functions

3.5.5

Construct spreadsheet for the specified purpose

3.5.6

Analyze data

3.5.7

Interpret results

Key Indicators:

3.6

Use word-processing software in work-related situations

3.6.1

Demonstrate knowledge of the functions and features of word-processing software

3.6.2

Construct word-processed documents for the specified purpose

3.6.3

Locate needed operations information using software documentation or help functions

3.6.4

Integrate databases, spreadsheets, graphics, and desktop publishing files into word-processed documents

3.6.5

Edit documents using available software features and functions

Key Indicators:

BEST COPY AVAILABLE

Working Responsibly - Strand

4

Core ITAC





Expectation

Work organizations value employees who possess the ability to work with diverse groups of people and who are able to lead others toward the achievement of common goals. Individuals must demonstrate a positive work ethic—exhibiting honesty, initiative, and dependability. In addition, they should understand the importance of ethical conduct and the role of ethics in professional organizations and work environments.

Competencies

- | | | | |
|-----|--|-----|---|
| 4.1 | Demonstrate leadership | 4.5 | Comply with the confidentiality requirements of workplace policies and procedures |
| 4.2 | Contribute to teamwork | | |
| 4.3 | Choose ethical courses of action in all work assignments and personal interactions | 4.6 | Apply appropriate strategies for dealing with the differences associated with diversity (e.g., racial, ethnic, gender, educational, personality, social, and age) |
| 4.4 | Demonstrate the work ethic | | |

Scenario

You are the director of human resources for a chain of retail stores. Lately there have been several incidents in which employees have treated customers rudely or unfairly because of the customers’ racial or ethnic background. You have been asked to provide training for employees that will encourage an appreciation of diversity, positive relations with customers, and an understanding of the legal and economic implications of inappropriate behavior. Present the training plan to your company’s management team for their approval.

Guiding Questions

- What are the benefits of multicultural diversity? What can business organizations do to support an appreciation of diversity?
- What are the contributions of various ethnic groups to businesses, communities, and society?
- What are the legal, social, and economic consequences of prejudicial or discriminatory actions for individuals, businesses, and communities?
- What laws prohibit discriminatory actions? In what context were these laws enacted?

BEST COPY AVAILABLE



4.1

Demonstrate leadership

- 4.1.1
- 4.1.2
- 4.1.3
- 4.1.4
- 4.1.5
- 4.1.6

Key Indicators:

- Identify a variety of leadership strategies
- Demonstrate leadership qualities
- Distinguish between the uses of leadership and management
- Analyze the factors influencing choice of leadership strategy in a given situation
- Match leadership strategies to the given group situation
- Collaborate with others to accomplish goals

4.2

Contribute to teamwork

- 4.2.1
- 4.2.2
- 4.2.3
- 4.2.4
- 4.2.5

Key Indicators:

- Demonstrate sensitivity to cultural, gender, and generational differences (in communication, interpersonal skills, and learning preferences)
- Demonstrate concern for each team member and for team goals (e.g., provide encouragement, maintain a can-do attitude and common focus)
- Complete aspects of assigned tasks according to team-established procedures and within specific timelines
- Employ group process techniques to solve problems, make decisions, build consensus, resolve or manage conflicts, construct compromises, support self-expression, and bring forth new ideas and opinions
- Evaluate the team's efforts

4.3

Choose ethical courses of action in all work assignments and personal interactions

- 4.3.1
- 4.3.2
- 4.3.3
- 4.3.4
- 4.3.5
- 4.3.6
- 4.3.7

Key Indicators:

- Establish a personal code of ethics
- Ensure that personal code of ethics is consistent with the professional code of ethics of the chosen profession
- Identify strategies that strengthen desirable character traits (including honesty, integrity, compassion, empathy, justice)
- Identify consequences of unethical conduct
- Recognize conflict between personal/professional ethics and the ethics of others
- Demonstrate awareness of legal responsibilities (e.g., copyright laws, harassment, equity)
- Identify strategies for responding to the unethical actions of individuals and organizations



4.4

Demonstrate the work ethic

4.4.1

Exhibit desirable personal and professional attitudes and behaviors (including positive view of self and work, awareness of impact on others, responsibility, pride)

4.4.2

Exhibit desirable personal and professional work habits and behaviors (including punctuality, regular attendance, quality performance, meeting or exceeding of job expectations, self-motivation, honesty)

4.4.3

Determine own role within the company's mission

4.4.4

Participate in required and voluntary professional development to benefit employer and self

4.4.5

Improve performance for the benefit of employer and self

4.4.6

Display a sense of personal responsibility for the welfare of the company and colleagues (including health, safety, environmental concerns)

4.4.7

Distinguish between work ethics of various organizations, work groups, and cultures

Key Indicators:

4.5

Comply with the confidentiality requirements of workplace policies and procedures

4.5.1

Identify types of confidential information (including mail and information about personnel, customers, company)

4.5.2

Maintain records on the distribution of information using established format and procedures

4.5.3

Provide information only to authorized personnel, whether transmitted physically or via technology

4.5.4

Inspect returned materials for completeness

4.5.5

Identify the consequences of a breach of confidentiality

Key Indicators:

4.6

Apply appropriate strategies for dealing with the differences associated with diversity (e.g., racial, ethnic, gender, educational, social and age)

4.6.1

Recognize the differences associated with diversity and the implications of those differences

4.6.2

Demonstrate effective interpersonal skills in working with others of different backgrounds

4.6.3

Express feelings, actions, and ideas respectfully

4.6.4

Identify appropriate strategies and solutions for dealing with cultural conflicts and differences

4.6.5

Demonstrate respect for diverse international business practices and etiquette

Key Indicators:

Planning and Managing a Career - Strand

5

Core ITAC

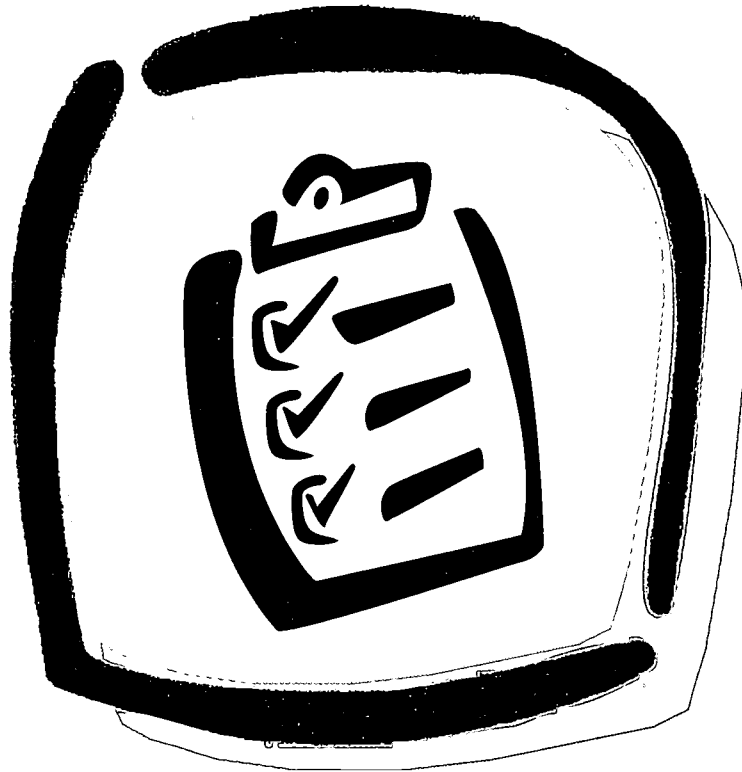



Expectation

Since work is a significant part of life, individuals need to be actively engaged in seeking a career that matches their interests, abilities, aptitudes, and skills. Career planning enhances the possibility that one’s career path will lead to success and satisfaction in work. Employers seek individuals who know what they want from work and can effectively present their qualifications and skills through the job search process, including job applications and interviews. Throughout one’s career, it is also important to seek continuous professional development opportunities.

Competencies

- | | |
|--|---|
| <p>5.1 Identify how personal interests, abilities, and skills relate to choosing a career</p> <p>5.2 Investigate career options</p> <p>5.3 Chart career using career-planning skills</p> | <p>5.4 Demonstrate skills needed to enter or reenter the workforce</p> <p>5.5 Demonstrate job-keeping skills</p> <p>5.6 Upgrade career skills</p> <p>5.7 Explore opportunities to create a business</p> |
|--|---|

Scenario

You have just been granted an interview for a position in the career area of your choice. Assuming you have completed all education and training necessary for this career, prepare to discuss why you selected the career, your long-range career goals, the skills you will bring to the workplace, and your long-term plan for professional development. Following the interview, obtain feedback about your ability to portray your interest and qualifications.

Guiding Questions

- What should you consider when planning a career?
- What are the implications of selecting a nontraditional career?
- What skills are needed to be successful in this career? How can you obtain those skills?
- Where can you obtain information about various careers and career opportunities?
- What communication skills will you use to convey your interest in and qualifications for this career?



5.1 **Identify how personal interests, abilities, and skills relate to choosing a career**

- Key Indicators:**
- 5.1.1 Determine own interests and aptitudes
 - 5.1.2 Relate personal interests to academic and occupational skills
 - 5.1.3 Identify impact of abilities and skills on career development
 - 5.1.4 Identify how self-knowledge relates to making career choices

5.2 **Investigate career options**

- Key Indicators:**
- 5.2.1 Identify career options, including self-employment and nontraditional careers
 - 5.2.2 Identify the range of available career information sources
 - 5.2.3 Research knowledge, abilities, and skills needed in each occupation using a variety of resources (e.g., handbooks, career materials, labor market information, computerized career-information delivery systems, and role models/mentors)
 - 5.2.4 Select careers that best match interests and aptitudes
 - 5.2.5 Analyze the impact of factors such as population, climate, employment trends, and geographic location on occupational choice
 - 5.2.6 Assess differences in the wages, benefits, annual incomes, cost of living, and job opportunities associated with selected career options
 - 5.2.7 Identify potential conflicts between interest/aptitudes and career choices
 - 5.2.8 Identify how career choices influence family, personal life, and lifestyle
 - 5.2.9 Assess labor market information pertaining to career options
 - 5.2.10 Explore future trends and occupations in the world of work

5.3 **Chart career using career-planning skills**

- Key Indicators:**
- 5.3.1 Demonstrate use of career information
 - 5.3.2 Identify elements of career planning
 - 5.3.3 Summarize the educational requirements of various occupations
 - 5.3.4 Identify skills that apply to a variety of occupations
 - 5.3.5 Identify challenges that may interfere with individual career plan (e.g., gender issues, misinformation, expectations of others, and conditions of labor market)
 - 5.3.6 Identify short-term and long-term goals for achieving career plan
 - 5.3.7 Develop a career plan
 - 5.3.8 Showcase interests, aptitudes, and skills utilizing a portfolio
 - 5.3.9 Annually review/revise the individual career plan



5.4

Demonstrate skills needed to enter or reenter the workforce

5.4.1

Apply knowledge of personal abilities, interests, and skills to the seeking of employment regionally, nationally, and globally

5.4.2

Develop job-getting tools (including résumés, letters of application, portfolios)

5.4.3

Demonstrate job-getting skills (including locating acceptable jobs, interviewing, completing a job application, and interpreting an employee contract)

5.4.4

Demonstrate skill in a second language if required for the position

5.4.5

Maintain a portfolio demonstrating job competence and containing job-getting tools

Key Indicators:

5.5

Demonstrate job-keeping skills

5.5.1

Demonstrate strong communication skills orally, in writing, or via computer

5.5.2

Apply basic arithmetic and mathematics skills to job tasks

5.5.3

Apply thinking skills to job tasks (including creative thinking, decision making, reasoning, problem solving, interpretation of information)

5.5.4

Apply interpersonal skills in relating to others on the job

5.5.5

Identify an awareness of employer expectations for the job

5.5.6

Carryout job tasks in accordance with employer expectations

5.5.7

Display positive work ethic

Key Indicators:

5.6

Upgrade career skills

5.6.1

Identify personal and workplace changes that require upgrading of own skills

5.6.2

Modify own career goals based on personal and workplace changes

5.6.3

Analyze various education/training options for securing needed upgrading

5.6.4

Identify professional development opportunities

5.6.5

Participate in professional development activities

5.6.6

Recognize need for lifelong upgrading of career skills

Key Indicators:



5.7

Explore opportunities to create businesses

5.7.1

Identify an unmet need or opportunity for provision of a good or service

5.7.2

Identify potential target markets nationally and/or internationally

5.7.3

Identify factors that contribute to the success or failure of a business

5.7.4

Evaluate the costs and benefits of future opportunities (e.g., renovations, improvements, expansions, addition of new products or services, international trade opportunities)

5.7.5

Evaluate entrepreneurship and intrapreneurship opportunities

5.7.6

Identify components of a business plan, considering various factors for identified opportunities and marketing strategies (including population, climate, location, supply and demand, competition)

Key Indicators:

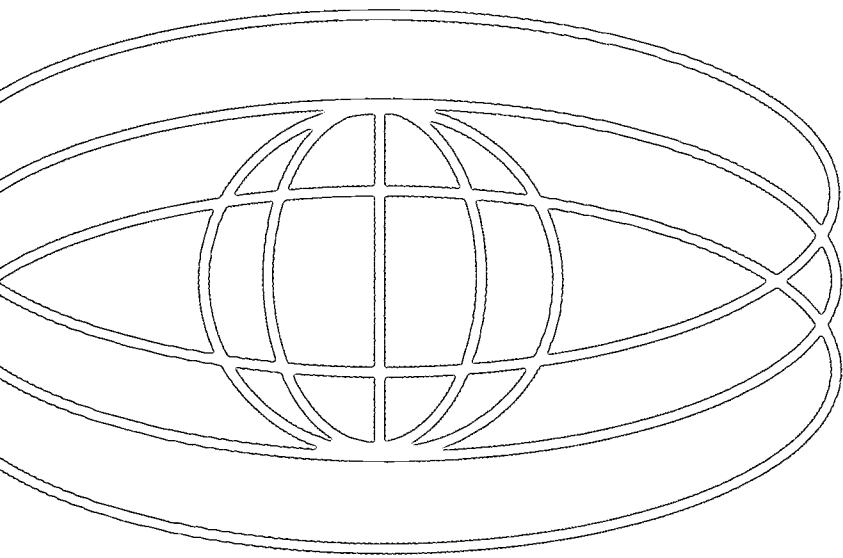

Managing Resources - Strand

6

Core ITAC

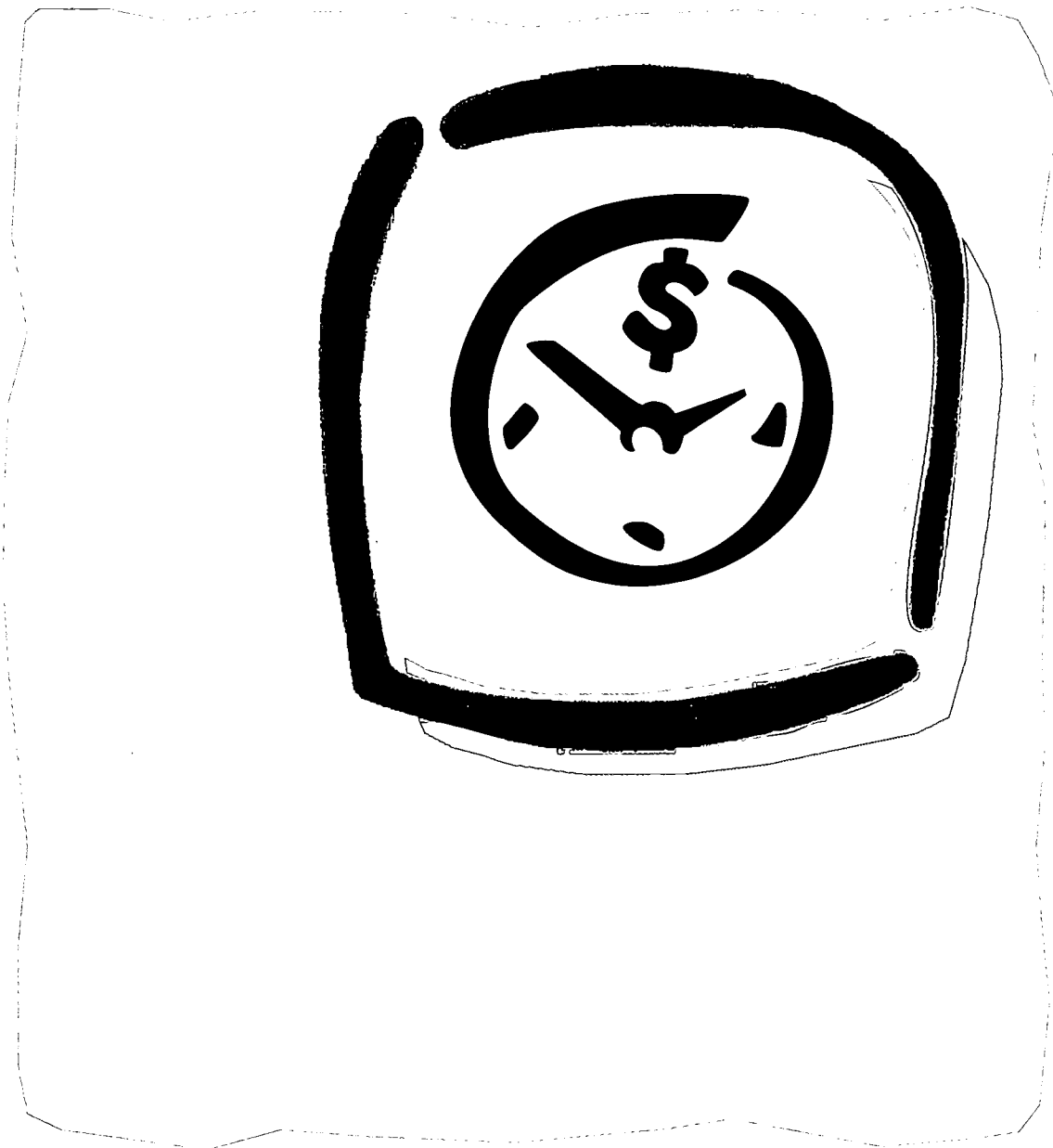



Expectation

In high-performance workplaces, all individuals must effectively manage a variety of resources—personal, financial, and environmental. Individuals’ ability to maintain good health, contribute to a safe work environment, and manage time not only enhances personal well-being, but fosters the success of the organization or business as well.

Competencies

- | | | | |
|-----|---|------|--|
| 6.1 | Apply self-management processes in the workplace | 6.7 | Manage work and family responsibilities for the well-being of self and others |
| 6.2 | Use reference materials to obtain information appropriate to a given problem, topic, or situation | 6.8 | Determine resources needed to produce a given product or provide a given service |
| 6.3 | Maintain/promote wellness | 6.9 | Ensure the quality of products and services |
| 6.4 | Determine the impact of government regulations and business/industry procedures on the performance of particular work functions | 6.10 | Utilize an inventory control system to track supplies, materials, and equipment |
| 6.5 | Implement safety procedures and programs | 6.11 | Make informed financial decisions |
| 6.6 | Support the provision of first aid in accordance with company policy and procedures | | |

Scenario

Your city has just experienced an outbreak of E.coli bacteria, which made a large percentage of the population ill. As a member of the city health department staff, your job is to analyze the potential causes of the outbreak and to educate the citizens and businesses in the community so as to prevent future outbreaks. Develop and present several communication tools, such as a 60-second television advertisement and a brochure, that convey your recommendations to prevent further contamination and illness.

Guiding Questions

- What food-handling and production practices contribute to E.coli contamination?
- What are the consequences of unsafe practices for individuals, businesses, and the community as a whole?
- What government regulations and business/industry policies impact the quality and safety of the foods we eat?
- How can individuals and families maintain good health and prevent E.coli contamination?



6.1 **Apply self-management processes in the workplace**

- 6.1.1 Develop a system for organizing work
- 6.1.2 Apply time-management skills
- 6.1.3 Apply anger-management skills
- 6.1.4 Apply stress-management skills
- 6.1.5 Arrange work environment based on the principles of ergonomics
- 6.1.6 Maintain a work area conducive to productivity (e.g., neat, orderly)
- 6.1.7 Manage resources to support achievement of goals

Key Indicators:

6.2 **Use reference materials to obtain information appropriate to a given problem, topic, or situation**

- 6.2.1 Obtain needed technological and informational reference materials
- 6.2.2 Collect information from selected references
- 6.2.3 Evaluate the validity and reliability of the information obtained
- 6.2.4 Organize information for use in problem solving, decision making, or communications
- 6.2.5 Apply information to workplace situations

Key Indicators:

6.3 **Maintain/promote wellness**

- 6.3.1 Recognize positive and negative influences on wellness (including social activities, sports, hobbies, environment, health, emotions, economics)
- 6.3.2 Participate in the arts disciplines and/or extracurricular activities (including dance, music, theater, visual arts, sports) that promote wellness and balance within an individual
- 6.3.3 Follow wellness principles that result in significant, measurable improvements in own overall health condition and the health condition of peer(s)
- 6.3.4 Monitor health and health parameters
- 6.3.5 Act on environmental issues that influence wellness

Key Indicators:



6.4

Determine the impact of government regulations and business/industry procedures on the performance of particular job functions

6.4.1

Identify the purpose of government regulations and their impact on the management of resources

6.4.2

Differentiate among federal, state, and local regulations and local business and industry procedures

6.4.3

Identify the various agencies involved in government oversight

6.4.4

Identify which regulations or guidelines take priority in a given situation

6.4.5

Locate information about the required process(es) for implementing regulations

6.4.6

Comply with regulations in the handling of materials, services, resources, and/or work activities (including inspection or self-monitoring)

Key Indicators:

6.5

Implement safety procedures and programs

6.5.1

Identify safety requirements

6.5.2

Demonstrate knowledge of safety rules and guidelines

6.5.3

Interpret safety signs and symbols

6.5.4

Demonstrate desirable safety attitudes and habits

6.5.5

Use safety equipment in accordance with established procedures

6.5.6

Document results of safety procedures and programs

Key Indicators:

6.6

Support the provision of first aid in accordance with company policy and procedures

6.6.1

Identify supplies and equipment needed in emergency situations

6.6.2

Locate supplies and equipment needed in emergency situations

6.6.3

Follow established procedures for the administration of first aid until official help arrives

6.6.4

Analyze the impact of stress throughout an emergency situation

6.6.5

Practice universal precautions during first aid procedures (including those related to blood-borne pathogens, confined spaces, emergency egress, fire safety, hearing conservation)

Key Indicators:

6.7

Manage work and family responsibilities for the well-being of self and others

6.7.1

Explore the meaning of work and the meaning of family

6.7.2

Analyze how work life is affected by families and how families are affected by work life

6.7.3

Implement strategies for balancing work and family roles

Key Indicators:



6.8

Determine resources needed to produce a given product or provide a service

6.8.1

Identify the different types of resources involved in the production of a product or provision of a service (e.g., financial, human, material, equipment)

6.8.2

Create a management plan for the allocation of financial resources to meet financial goals

6.8.3

Plan for the appropriate allocation and use of materials and equipment

6.8.4

Plan for the allocation and use of human resources

6.8.5

Plan for the allocation and use of information and technology needed to make and support decisions

6.8.6

Plan for the allocation and use of natural resources

6.8.7

Plan for the allocation and use of space so as to make the best use of facilities for goal achievement

Key Indicators:

6.9

Ensure the quality of products and services

6.9.1

Identify the importance of individual and organizational productivity in the workplace and how it affects the profitability of the business

6.9.2

Determine the quality- and quantity-control standards and procedures required to produce a specific product or provide a specific service

6.9.3

Inspect the production of the product or provision of the service to assure quality levels

6.9.4

Monitor production of products and provision of services

6.9.5

Select equipment and raw materials that will support quality in the process of producing a product or providing a service

6.9.6

Interpret quantitative and qualitative records to identify problems and provide a basis for making decisions about the production of products and provision of services

6.9.7

Provide appropriate documentation regarding the quality of products and services

6.9.8

Identify corrective actions needed to improve the quality of products and services

6.9.9

Create new methods for improving the quality of products and services

Key Indicators:

6.10

Utilize an inventory control system to track supplies, materials, and equipment

6.10.1

Determine the factors, including regulations, that influence the type of control system used

6.10.2

Develop an inventory system

6.10.3

Maintain the inventory system

6.10.4

Report the inventory results

Key Indicators:



6.11

Make informed financial decisions

6.11.1

Identify the need for personal financial management records

6.11.2

Create a budget

6.11.3

Evaluate the effectiveness of the budget

6.11.4

Demonstrate knowledge of how credit affects personal/family finances

6.11.5

Identify the steps to follow to avoid credit problems

6.11.6

Make informed consumer choices in response to personal needs and wants

6.11.7

Identify the factors that influence consumer decisions (e.g., advertisements, peer groups, price, location)

6.11.8

Recognize the value of company benefits and the importance of retirement planning

6.11.9

Identify the costs and benefits for individuals of various types of taxation at the local, state, and federal levels

Key Indicators:

.....

Academic Connections in Core ITAC

Academic Connections answer the question, “What knowledge and skills from the Ohio Competency-Based Education (CBE) Models are essential to the achievement of the Core competencies?” The academic content represented in the ITAC includes the subject areas from six models:



The Arts



Mathematics



Social Studies



Language Arts



Foreign Language









Science







These connections were identified by relating the content of the competencies in the Core ITAC strands to essential content from the objectives in the Ohio CBE Models. ITAC key indicators for each competency were used to clarify the nature and specificity of the connection. Subject-matter experts in each academic area verified the connections.







The following chart is a summary of the percentages of connections for each model. For specific connections between the core competencies and objectives in each model, visit the following website: <www.cete.org/products>. This summary does not represent all possible opportunities for interdisciplinary curriculum development. Many other connections could be made during the instructional process through authentic projects or workplace situations that involve related content.

Academic Connections in Core ITAC

The chart below illustrates the relationship between the Core ITAC and the objectives in Ohio's Competency-Based Education (CBE) Models. Each column represents the percent of the total number of CBE objectives, PreK–12 grade, that are related to each core competency.

Core ITAC	Academic Models					
Competencies	Percent of Model Relating to Core ITAC					
	 The Arts	 Math	 Social Studies	 Language Arts	 Foreign Language	 Science
Strand 1 — Solving Problems and Thinking Skillfully						
1.1 Solve problems and make decisions in work-related situations	52%	16%	4%	24%	0%	54%
1.2 Read for information and understanding	5%	1%	19%	33%	5%	32%
1.3 Use observation skills to analyze work-related situations	27%	5%	1%	42%	2%	39%
1.4 Apply mathematical processes	0%	62%	1%	<1%	4%	24%
1.5 Apply measurement and spatial skills	0%	22%	1%	0%	4%	28%
1.6 Apply statistical analysis skills	<1%	9%	<1%	1%	0%	12%
1.7 Analyze critical data to guide work activities	5%	0%	1%	1%	0%	27%
1.8 Utilize scheduling techniques to ensure that jobs are completed by the stated due date	<1%	0%	0%	3%	0%	1%
1.9 Demonstrate knowledge of the economy and how it functions as a whole	6%	0%	6%	1%	2%	0%
1.10 Demonstrate knowledge of the economy as a framework within which decisions are made by individuals and groups	3%	2%	6%	1%	4%	0%
Strand 2 — Communicating Effectively						
2.1 Apply basic communication skills	79%	3%	1%	67%	50%	20%
2.2 Apply oral communication skills	14%	5%	0%	18%	37%	10%
2.3 Apply written communication skills	5%	2%	0%	29%	13%	9%
2.4 Apply technical writing skills	2%	0%	0%	1%	0%	5%
2.5 Apply listening skills	4%	0%	1%	21%	8%	9%
2.6 Apply demonstration/presentation skills	20%	<1%	0%	6%	7%	4%
2.7 Apply graphic communication skills	12%	9%	2%	4%	5%	5%
2.8 Apply artistic communication skills	96%	<1%	1%	27%	8%	3%
2.9 Convey information through multimedia presentation	13%	0%	0%	2%	1%	4%
2.10 Create graphs and charts	3%	10%	2%	4%	5%	6%
2.11 Build interpersonal relationships	4%	0%	4%	5%	11%	7%

Core ITAC	Academic Models					
Competencies	Percent of Model Relating to Core ITAC					
	 The Arts	 Math	 Social Studies	 Language Arts	 Foreign Language	 Science
Strand 3 — Applying Technology						
3.1 Demonstrate technological literacy	5%	1%	1%	0%	0%	8%
3.2 Access/transmit information using electronic communication systems	<1%	0%	0%	2%	11%	2%
3.3 Demonstrate computer literacy	4%	2%	0%	4%	3%	4%
3.4 Use database software in work-related situations	0%	0%	0%	<1%	0%	3%
3.5 Use spreadsheet software in work-related situations	0%	<1%	0%	0%	0%	2%
3.6 Use word-processing software in work-related situations	<1%	0%	0%	2%	2%	2%
Strand 4 — Working Responsibly						
4.1 Demonstrate leadership	0%	0%	2%	1%	0%	4%
4.2 Contribute to teamwork	20%	0%	5%	23%	4%	5%
4.3 Choose ethical courses of action in all work assignments and personal interactions	0%	0%	<1%	1%	0%	4%
4.4 Demonstrate the work ethic	<1%	0%	1%	13%	3%	4%
4.5 Comply with the confidentiality requirements of workplace policies and procedures	0%	0%	0%	<1%	0%	1%
4.6 Apply appropriate strategies for dealing with the differences associated with diversity (e.g., racial, ethnic, gender, educational, personality, social, and age)	20%	0%	8%	20%	8%	4%
Strand 5 — Planning and Managing a Career						
5.1 Identify how personal interests, abilities, and skills relate to choosing a career	8%	0%	1%	11%	2%	1%
5.2 Investigate career options	6%	0%	0%	<1%	3%	1%
5.3 Chart career using career-planning skills	2%	0%	0%	<1%	2%	1%
5.4 Demonstrate skills needed to enter or reenter the workforce	4%	0%	<1%	1%	5%	<1%
5.5 Demonstrate job-keeping skills	0%	0%	0%	8%	<1%	0%
5.6 Upgrade career skills	0%	0%	0%	0%	0%	0%
5.7 Explore opportunities to create businesses	2%	0%	3%	0%	1%	0%

Core ITAC	Academic Models					
Competencies	Percent of Model Relating to Core ITAC					
	 The Arts	 Math	 Social Studies	 Language Arts	 Foreign Language	 Science
Strand 6 — Managing Resources						
6.1 Apply self-management processes in the workplace	5%	0%	3%	8%	8%	3%
6.2 Use reference materials to obtain information appropriate to a given problem, topic, or situation	12%	0%	1%	7%	<1%	4%
6.3 Maintain/promote wellness	<1%	0%	0%	8%	1%	1%
6.4 Determine the impact of government regulations and business/industry procedures on the performance of particular work functions	0%	0%	4%	0%	0%	0%
6.5 Implement safety procedures and programs	12%	0%	0%	<1%	0%	3%
6.6 Support the provision of first aid in accordance with company policy and procedures	0%	0%	0%	0%	0%	0%
6.7 Manage work and family responsibilities for the well-being of self and others	0%	0%	0%	<1%	0%	<1%
6.8 Determine resources needed to produce a given product or provide a given service	11%	0%	6%	2%	0%	1%
6.9 Ensure the quality of products and services	22%	0%	0%	8%	0%	<1%
6.10 Utilize an inventory control system to track supplies, materials, and equipment	0%	0%	0%	<1%	0%	<1%
6.11 Make informed financial decisions	0%	0%	2%	<1%	0%	0%

Core ITAC Acknowledgments

The Vocational Instructional Materials Laboratory extends thanks and appreciation to the many representatives of business, industry, labor, and community organizations who contributed their time and expertise to the identification and verification of competencies.

The following panel participants verified the technical and academic competencies in the Core ITAC:

Laura Berk, The Center for Manufacturing Excellence, Toledo, Ohio
Kay Briggs, Coalition of Neighborhoods, Cincinnati, Ohio
Walter R. Cates, Sr., Main Street Business Association, Columbus, Ohio
Cap Clegg, Columbus Financial Concepts, Dublin, Ohio
Randy Deatherage, Agnew Farm Equipment, Youngstown, Ohio
Timothy A. Ely, Beacon Electric, Cincinnati, Ohio
Diane Findley, RN, Paul E. Detty MD Inc., Lancaster, Ohio
Sheila Kane, The Andersons General Store, Columbus, Ohio
Keith Meske, Educable TV 25, Columbus, Ohio
Sandy O'Connor, Clark County Dept. of Human Services, Springfield, Ohio
Joyce E. Odor, Columbus Public Schools, Columbus, Ohio
James H. Orsborn, American Electric Power, Columbus, Ohio
Robert A. Osterling, Hy-Level Industries, Cleveland, Ohio
Charlie Pinter, Kroger, Gahanna, Ohio
Scott J. Wallace, Red Roof Inns, Inc., Hilliard, Ohio
Van S. White, Human Resources Consultant, Cincinnati, Ohio
Morris Williams, Coalition of Neighborhoods, Cincinnati, Ohio

The following educator review panel was responsible for reviewing the integrated technical and academic competencies in the Core ITAC:

Virginia Ballinger, Ohio Department of Education, Columbus, Ohio
Heather Boggs, Ohio Department of Education, Columbus, Ohio
David Cairns, Warren County JVSD, Lebanon, Ohio
Denise P. Clapp, Hilliard Davidson High School, Hilliard, Ohio
Carmen R. Giebelhaus, Ohio Department of Education, Columbus, Ohio
Karen P. Heath, Ohio Department of Education, Columbus, Ohio
Peggy Kasten, Ohio Department of Education, Columbus, Ohio
Abbejean Kehler, Ohio Council on Economic Education, Columbus, Ohio
Betty Kulich, Fort Hayes Metro Education Center, Columbus, Ohio
Jerry Mahl, EHOVE Career Center, Milan, Ohio
Kent J. Minor, Ohio Department of Education, Columbus, Ohio
Roberta Newcomer, Ohio Department of Education, Columbus, Ohio
Linda Thomas, Hayes Technical School, Grove City, Ohio
Susan Washam Witten, Ohio Department of Education, Columbus, Ohio

The following individuals provided technical assistance in identifying competencies, writing statements of expectation, and developing scenarios for the Integrated Technical and Academic Competencies (ITAC). Their assistance is much appreciated.

Dr. Ruth Loring, Center for Occupational Research and Development, Waco, Texas

Jane Sanborn, MPR Associates, Inc. and the National Center for Research in Vocational Education, Berkeley, California

Dr. Joyce Malyn-Smith, Education Development Center, Inc., Newton, Massachusetts.

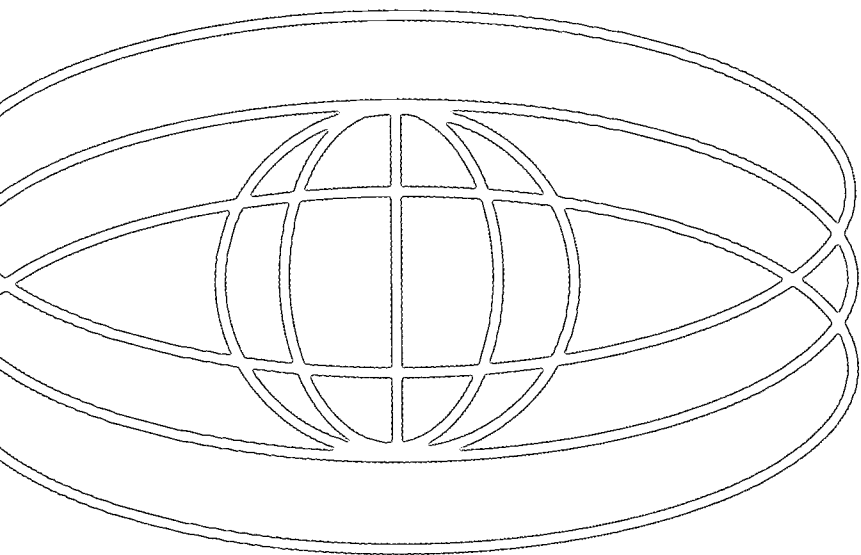

Environmental & Agricultural Systems Career Cluster ITAC

.....

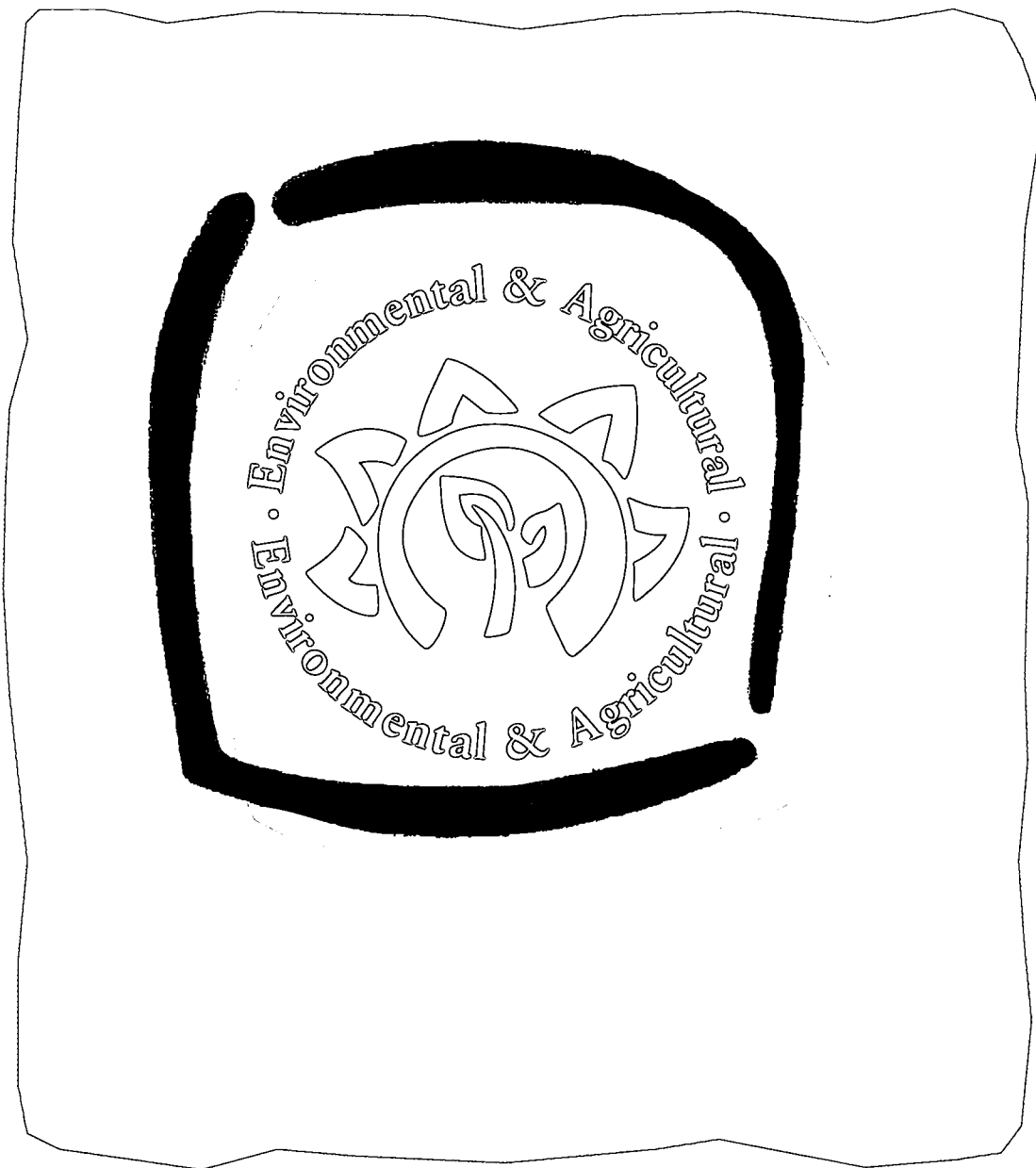

Components of Career Cluster ITACs

Career Clusters:

- Arts & Communications
- Business & Management
- Industrial & Engineering Systems
- Human Resources/Services
- Environmental & Agricultural Systems
- Health Services

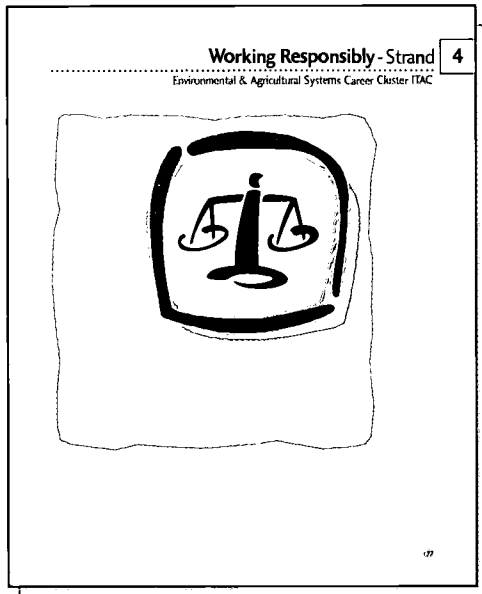

Each strand in a Career Cluster ITAC has an introduction page which identifies the strand (in words and by icon) and the career cluster. These pages also appear in the Core ITAC.

Expectation – a statement of desired workplace behaviors and their importance in the world of work.

Competencies – observable and measurable knowledge, skills, and attitudes essential to achievement of the expectation.

Strand 4 – Working Responsibly – Environmental & Agricultural Systems Career Cluster ITAC

Expectation

Working responsibly encompasses skills in citizenship, community awareness, and management. Individuals must daily demonstrate a strong work ethic, including — but not limited to — honesty, initiative, and dependability. Individuals must be able to discern between right and wrong in difficult or subtle situations. Then, they must act with rightness, fairness, and equity. Individuals must be free from petty, mean, or dubious conduct if an organization is to thrive. Without high standards of ethical conduct on both sides, individuals and organizations are subject to low morale and a host of management, legal, economic, and political problems.

Competencies

4.1 Identify significant environmental and agricultural issues	4.2 Apply citizenship skills
	4.3 Improve community awareness

Scenario

You are a food-processing quality-control employee for a major food manufacturer. There has been a recent rise in the number of food-borne illnesses and deaths (Lysteria, E.coli) in your state. Recently, your company recalled over 10,000 pounds of product that may be related to a food-related illness. The local agricultural broadcasting network has asked to interview you on the impact of the potential illnesses and what precautions your company is taking to protect its customers from harm. Your immediate supervisor has asked you to prepare an outline that will assist you and the journalist with the interview.

Guiding Questions

- What are the company's legal and ethical responsibilities?
- What would be the consequences to the company and industry for behaving unethically?
- How will you determine what the community needs to know about the food-borne illnesses?
- What plan of action will your company develop to address the issue at hand and to show the company's responsibility to the community?



Solving Problems and Thinking Skillfully



Communicating Effectively



Applying Technology



Working Responsibly

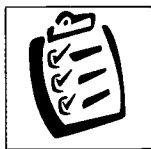

Planning and Managing a Career



Managing Resources

Sample Scenario – a real-life workplace situation requiring learners to apply the knowledge and skills reflected in the strand competencies.

Sample Guiding Questions – targeted questions to use in focusing learners' attention on knowledge and skills covered in the scenario.

Connections to Core ITAC Competencies – a list, by number, of key competencies in Core ITAC that relate to and/or reinforce the competencies in the given strand and cluster.

Environmental & Agricultural Systems Career Cluster ITAC – Working Responsibly – Strand 4

Core ITAC	Competency Connections
Strand 1: Solving Problems and Thinking Skillfully	1.1, 1.2
Strand 2: Communicating Effectively	2.1, 2.2, 2.3, 2.5, 2.11
Strand 3: Applying Technology	None
Strand 4: Working Responsibly	4.1, 4.3, 4.4, 4.6
Strand 5: Planning and Managing a Career	None
Strand 6: Managing Resources	6.1, 6.2

Academic Connections

 **Social Studies**

- American Heritage:** Identify significant developments in history, and gauge their impact on subsequent events
- American Heritage:** Draw connections between ideas, interests, beliefs, and ideologies and their influence on individual and group historical actions
- American Heritage:** Identify key historical events, and explain their impact on subsequent developments
- World Interactions:** Utilize a variety of references to analyze and develop plausible explanations for historic and current events
- World Interactions:** Describe human modifications of the physical environment that have had intended, as well as unintended, effects; and consider alternative approaches to dealing with the environment
- Democratic Processes:** Justify proposed solutions to current issues by explaining how they adhere to democratic principles
- Citizenship Rights and Responsibilities:** Acquire, interpret, and analyze information regarding civic issues; evaluate the reliability of available information; identify and weigh alternative viewpoints
- Citizenship Rights and Responsibilities:** Explain why it is important for citizens to participate in the public policy process
- Citizenship Rights and Responsibilities:** Analyze the impact of citizen participation on significant issues
- Citizenship Rights and Responsibilities:** Identify and critique the responsibilities of citizenship in a democratic society
- Citizenship Rights and Responsibilities:** Evaluate voluntary efforts in terms of what citizens gain and contribute and their effects on the common welfare
- Citizenship Rights and Responsibilities:** Work as an individual or as part of a group on a significant issue

Connections to Academic Models – a list of objectives from Ohio's Competency-Based Education Models, grades 9–12, that relate to and/or reinforce the competencies in the given strand and cluster. Each academic area is represented by an icon.

Environmental & Agricultural Systems Career Cluster ITAC – Working Responsibly – Strand 4

Competencies & Key Indicators

4.1 **Identify significant environmental and agricultural issues**

4.1.1 Identify the interrelationships between agriculture and the environment

4.1.2 Research the history of environmental issues, regulations, and uses of natural resources

4.1.3 Identify choices that reflect responsible and irresponsible uses of the natural environment

4.1.4 Forecast issues for the environmental and agricultural industries

4.2 **Apply citizenship skills**

4.2.1 Recognize the importance of leadership to citizenship

4.2.2 Recognize the importance of leadership, volunteerism, and community service to citizenship

4.2.3 Assess the value of leadership, volunteerism, and community service

4.2.4 Identify leadership qualities

4.2.5 Identify the qualities of a responsible volunteer

4.2.6 Participate in leadership, volunteerism, and community service opportunities

4.3 **Improve community awareness**

4.3.1 Determine community needs

4.3.2 Identify community service projects

4.3.3 Identify facility/agency policies and protocols

4.3.4 Develop agricultural awareness in the community

4.3.5 Develop community's awareness of agricultural education history

4.3.6 Develop community's awareness of agricultural youth organization history

4.3.7 Identify impacts of environmental and agricultural organizations on the community

4.3.8 Identify governmental structures within the community

Pages following the overview list each competency with its key indicators. Key indicators describe significant elements of competency performance.

Connections to Ohio's Proficiency Tests and ACT Work Keys® – a crosswalk between ITACs (core, cluster, specialization) and assessments that reflect student exit outcomes.



The Arts



Mathematics



Social Studies



Language Arts

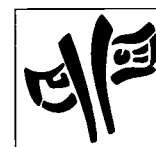

Foreign Language



Science



Solving Problems and Thinking Skillfully - Strand

1

.....
Environmental & Agricultural Systems Career Cluster ITAC

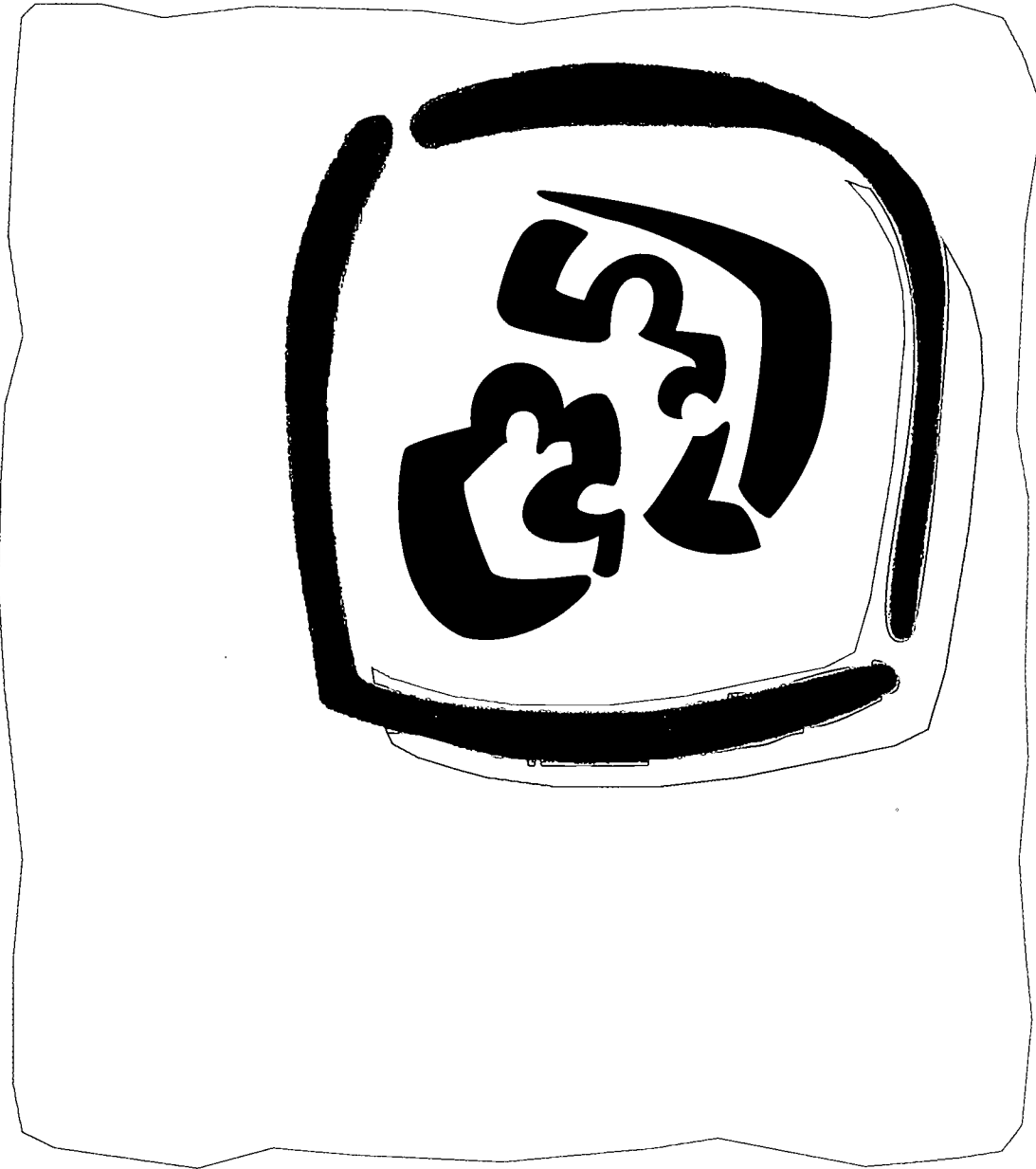



Expectation

All individuals, regardless of career choice, must be able to think for themselves; initiate action on their own; and direct, modify, and assess their own work. Lifelong learners must be able to locate and use information. The competencies in this strand focus upon environmental and global perspectives, research and development, and economic applications. The competencies specify the knowledge, skills, and attitudes needed to develop the capacity to assess problems and situations, anticipate what might happen next, and continuously search for creative solutions.

Competencies

- | | | | |
|-----|--|------|---|
| 1.1 | Use scientific inquiry to solve problems | 1.7 | Analyze the relationships between group and community choices and their impact on environmental and agricultural industries |
| 1.2 | Examine current research | 1.8 | Compare ecosystems |
| 1.3 | Conduct research projects | 1.9 | Analyze the economic importance of the environmental and agricultural industries |
| 1.4 | Develop a local environmental and agricultural perspective concerning economic and social impacts | 1.10 | Analyze trends and issues in the environmental and agricultural industries |
| 1.5 | Develop a global environmental and agricultural perspective concerning the nations and peoples of the world | 1.11 | Perform accounting functions |
| 1.6 | Analyze the relationships between individual choices and their impact on environmental and agricultural industries | | |

BEST COPY AVAILABLE



Scenario

You are a wildlife officer who resides in a rural community in an area where there is proposal to install a factory farm: an egg production facility with 10 million laying hens. A local community park borders the proposed site. The community is highly concerned about the economic and environmental impact of the factory farm. Residents are particularly concerned about air, water, and land pollution. They also need to clarify the economic advantages and disadvantages to the community. A community organization has raised \$10,000 to conduct research and investigations to provide information for making decisions. As a volunteer for the organization, you have been selected to lead a committee that will determine what research and investigations are needed. At the next community meeting, you will be expected to present a plan and rationale for conducting specific research and investigations and criteria for determining how to spend the money. After the research and investigations have been completed, you will need to present the findings at a community meeting.



Guiding Questions

- How will you determine what needs to be researched and investigated?
- What procedures should be followed in collecting the information and conducting the research?
- How will you ensure that the research and investigations produce reliable and valid information?
- What agencies would be useful to contact for assistance?
- What community and environmental factors will affect your plan?

BEST COPY AVAILABLE



Core ITAC	Competency Connections
Strand 1: Solving Problems and Thinking Skillfully	1.1, 1.2, 1.3, 1.4, 1.6, 1.7, 1.9, 1.10
Strand 2: Communicating Effectively	2.1, 2.3, 2.4
Strand 3: Applying Technology	3.1, 3.3, 3.4, 3.5, 3.6
Strand 4: Working Responsibly	4.3, 4.6
Strand 5: Planning and Managing a Career	None
Strand 6: Managing Resources	6.2, 6.4, 6.11

Academic Connections	
	<p>Math</p> <ul style="list-style-type: none"> • Patterns, Relations, and Functions: Model real-world phenomena with polynomial and exponential functions • Algebra: Describe problem situations by using and relating numerical, symbolic, and graphical representations • Algebra: Set up and solve linear equations • Algebra: Solve systems of linear equations with two variables • Algebra: Describe measures of central tendency, mean, median, mode, and variance, algebraically and graphically • Data Analysis and Probability: Understand and apply measures of central tendency, variability, and correlation • Data Analysis and Probability: Transform data to aid in data interpretation and prediction • Data Analysis and Probability: Test hypotheses using appropriate statistics • Data Analysis and Probability: Read, interpret, and use tables, charts, and graphs to identify patterns, note trends, draw conclusions, and make predictions • Data Analysis and Probability: Design a statistical experiment to study a problem, conduct the experiment, and interpret and communicate the outcomes
	<p>Social Studies</p> <ul style="list-style-type: none"> • People in Societies: Analyze the social and economic impact of the transformation from an agrarian, rural society to an industrialized, urban society • People in Societies: Compare the development of three cultures on three different continents from 1919 to the present with regard to art, literature, and music; customs, traditions, and social developments; economic systems; governments; philosophical and religious ideas; relationship to the environment; science and technology • World Interactions: Describe ways in which natural processes and human activities contribute to global environmental problems



Academic Connections



Social Studies (cont.)

- **World Interactions:** Cite examples of social, economic, and political interdependence in history
- **World Interactions:** Utilize a variety of references to analyze and develop plausible explanations for historic and current events
- **Decision Making and Resources:** Compare the transformation of the United States from an agrarian to an industrial nation with similar transformations in other countries
- **Decision Making and Resources:** Identify the external benefits and costs of economic activities
- **Democratic Processes:** Evaluate the ways in which public interest groups and special interest groups impact efforts to achieve the public good
- **Citizenship Rights and Responsibilities:** Identify sources of propaganda, describe the most common techniques, and explain how propaganda is used to influence behavior



Language Arts

- **Reading/Application:** Employ various reading strategies according to purpose
- **Reading/Meaning Construction:** Confirm and extend meaning in reading by researching new concepts and facts
- **Reading/Meaning Construction:** Use reading as a possible problem-solving strategy to clarify personal thinking and understanding
- **Writing/Structure:** Develop writing that contains ordered, related, well-developed paragraphs with sentences of varied lengths and patterns
- **Writing/Meaning Construction:** Evaluate, analyze, and synthesize information for writing
- **Writing/Application:** Apply appropriate writing techniques suitable for varied writing tasks



Foreign Language

- **Cultural Knowledge:** Develop sensitivity to cultural differences
- **Multidisciplinary Connections, Information, and Knowledge:** Identify and discuss issues common to the home and target cultures
- **Multidisciplinary Connections, Information, and Knowledge:** Gain knowledge about societal issues in the target culture(s) through a variety of authentic texts and media
- **Multidisciplinary Connections, Information, and Knowledge:** Use authentic resources (print and media) to analyze and discuss current issues from the perspectives of the home and target culture(s)
- **Multidisciplinary Connections, Information, and Knowledge:** Explore and analyze how people in the target culture(s) solve societal issues (e.g., terrorism, welfare, unemployment, health care)



Academic Connections



Science

- **Scientific Inquiry:** Design investigations that are safe and ethical (e.g., obtain consent and inform others of potential outcomes, risks, and benefits; and show evidence of concern for human health and safety, concern for nonhuman species)
- **Scientific Inquiry:** Design and conduct investigations with multiple variables
- **Scientific Inquiry:** Create multiple representations of the same data using a variety of symbols, descriptive languages, mathematical concepts, and graphic techniques
- **Scientific Inquiry:** Modify personal opinions, interpretations, explanations, and conclusions based on new information
- **Scientific Inquiry:** Analyze the changes within a system when inputs, outputs, and interactions are altered
- **Scientific Knowledge:** Investigate the relationship between the rates of energy exchange and the relative energy level of components within systems (e.g., trophic levels of ecosystems; osmosis, rate of heating and cooling, storms)
- **Scientific Knowledge:** Investigate the historical development of theories of change over time (e.g., natural selection, continental drift, the big bang, geologic change)
- **Scientific Knowledge:** Formulate explanations and representations of the production transmission, and conservation of energy in biological and physical systems (e.g., weather, volcanism, earthquakes, electricity, magnetism, cellular respiration)
- **Conditions for Learning Science:** Investigate social issues with a scientific perspective (e.g., human rights, wellness, economics, futurism, environmental ethics)
- **Conditions for Learning Science:** Determine the validity of research conclusions in relation to the design, performance, and results
- **Conditions for Learning Science:** Conduct learner-developed investigations independently and collaboratively over periods of weeks and months
- **Conditions for Learning Science:** Perform investigations that require observations over varying periods of time
- **Conditions for Learning Science:** Participate actively in dialogue about and resolution of community issues
- **Conditions for Learning Science:** Examine the influences of social and political structures and realities that contribute to inquiry about scientific issues
- **Conditions for Learning Science:** Develop possible courses of action in response to scientific issues of local and global concern
- **Applications for Science Learning:** Promote and carry out practices that contribute to a sustainable environment



Academic Connections



Science (cont.)

- **Applications for Science Learning:** Do simple troubleshooting on common electrical and mechanical systems, identifying and eliminating possible causes of malfunctions
- **Applications for Science Learning:** Promote public awareness of the interaction of technology with social issues
- **Applications for Science Learning:** Develop and write environmental impact, and safety and hygiene management plans
- **Applications for Science Learning:** Analyze the contributions of advances in technology through history to own everyday life
- **Applications for Science Learning:** Make informed consumer choices by evaluating and prioritizing information, evidence, and strategies
- **Applications for Science Learning:** Evaluate the social and ecological risks and benefits resulting from the use of various consumer products
- **Applications for Science Learning:** Choose consumer materials utilizing personal and environmental risk and benefit information
- **Applications for Science Learning:** Develop an informed point of view that allows for validation or refutation of the scientific statements and claims of advocates before pursuing courses of action (e.g., contributing support, signing petitions, casting votes)
- **Applications for Science Learning:** Make decisions regarding personal and public health



Competencies & Key Indicators

1.1

Use scientific inquiry to solve problems

1.1.1

Identify the purpose of scientific inquiry

1.1.2

Identify the steps in scientific inquiry

1.1.3

Identify the characteristics of scientific inquiry

1.1.4

Examine scientific relationships

1.1.5

Formulate interpretations, explanations, and representations

1.1.6

Apply scientific inquiry to given problems

Key Indicators:

1.2

Examine current research

1.2.1

Distinguish between science and technology

1.2.2

Assess risks and benefits of technology in a given area

1.2.3

Assess risks and benefits of agricultural technology to society

1.2.4

Determine validity and reliability of research

1.2.5

Analyze current research effects in a given area

Key Indicators:

1.3

Conduct research projects

1.3.1

Identify the general procedures for conducting research

1.3.2

Conduct comprehensive research using relevant resources

1.3.3

Design an experiment using appropriate control measures

1.3.4

Devise a system for recording data

1.3.5

Identify components of a research report

1.3.6

Describe the experiment conducted

1.3.7

Summarize data using charts or graphs

1.3.8

Draw conclusions from summarized data

1.3.9

Prepare a formal research report for conducted experiment

1.3.10

Prepare an abstract for the research report

Key Indicators:



1.4

Develop a local environmental and agricultural perspective concerning economic and social impacts

1.4.1

Recognize the value and impact of local agricultural diversity

1.4.2

Analyze the implications of local issues

1.4.3

Identify import and export products

1.4.4

Evaluate the status of local agriculture

1.4.5

Summarize the status of the local agricultural and environmental industries

Key Indicators:

1.5

Develop a global environmental and agricultural perspective concerning the nations and peoples of the world

1.5.1

Recognize the value and impact of world agricultural diversity

1.5.2

Identify the impact of international trade, quotas, and tariffs

1.5.3

Identify import and export products

1.5.4

Analyze the interdependency of nations

1.5.5

Analyze the implications of world issues

1.5.6

Evaluate the status of international agriculture

1.5.7

Evaluate the economic, political, and social importance of the agricultural and environmental industries

1.5.8

Summarize the status of the global agricultural and environmental industries

1.5.9

Analyze interactions between local, regional, national, and international environmental and agricultural interests

Key Indicators:

1.6

Analyze the relationships between individual choices and their impact on environmental and agricultural industries

1.6.1

Analyze ethical issues related to growing food and animals (pesticide usage, animal care and processing)

1.6.2

Identify the consequences of consumption versus conservation (e.g., rainforests, wetlands)

1.6.3

Identify how individual actions impact others

1.6.4

Identify costs and trade-offs when making choices as individual consumers

Key Indicators:

BEST COPY AVAILABLE



1.7

Analyze the relationships between group and community choices and their impact on environmental and agricultural industries

- 1.7.1
- 1.7.2
- 1.7.3
- 1.7.4
- 1.7.5
- 1.7.6

Key Indicators:

- Research environmental/economical impact statements and related issues
- Analyze public interest group actions and statements
- Differentiate between communications that are reliable and valid and those presenting propaganda
- Determine best interests in accordance with the public good
- Explore how groups and communities organize for the good of the environment
- Identify costs and trade-offs when making choices as a community and nation

1.8

Compare ecosystems

- 1.8.1
- 1.8.2
- 1.8.3
- 1.8.4
- 1.8.5
- 1.8.6
- 1.8.7
- 1.8.8
- 1.8.9
- 1.8.10

Key Indicators:

- Identify how energy flows through ecosystems
- Identify how materials are cycled in ecosystems
- Determine ways in which efficiency applies to energy flow in food webs
- Determine ways in which agricultural systems differ from natural ecosystems
- Determine ways in which humans have altered biological cycles
- Identify the interacting spheres that make up our ecosphere
- Identify the steps in the process of ecological succession
- Identify microorganisms used to improve our ecology
- Identify plant preferences for specific ecosystems
- Evaluate ecological land-use relationships

1.9

Analyze the economic importance of the environmental and agricultural industries

- 1.9.1
- 1.9.2
- 1.9.3
- 1.9.4

Key Indicators:

- Determine the economic importance of animals
- Determine the economic importance of plants
- Determine the economic importance of nonrenewable resources
- Determine how social and political issues impact economic importance

BEST COPY AVAILABLE



1.10

Analyze trends and issues in the environmental and agricultural industries

1.10.1

Keep up-to-date regarding technology in tools, equipment, materials, and practices (e.g., biotech, robotics, geographical information system [GIS], Internet markets)

1.10.2

Analyze environmental issues related to the environmental and agricultural industries

1.10.3

Analyze changes in production and alternative agriculture

1.10.4

Analyze changes in marketing and selling trends

1.10.5

Identify the influences causing trends

Key Indicators:

1.11

Perform accounting functions

1.11.1

Prepare inventories

1.11.2

Maintain inventories

1.11.3

Develop depreciation schedules

1.11.4

Develop budgets

1.11.5

Apply accounting concepts, principles, and procedures

1.11.6

Prepare cost and revenue analyses

1.11.7

Summarize financial reports

1.11.8

Calculate simple and compound interest

1.11.9

Calculate a bill of materials

Key Indicators:

BEST COPY AVAILABLE



Communicating Effectively - Strand

2

Environmental & Agricultural Systems Career Cluster ITAC

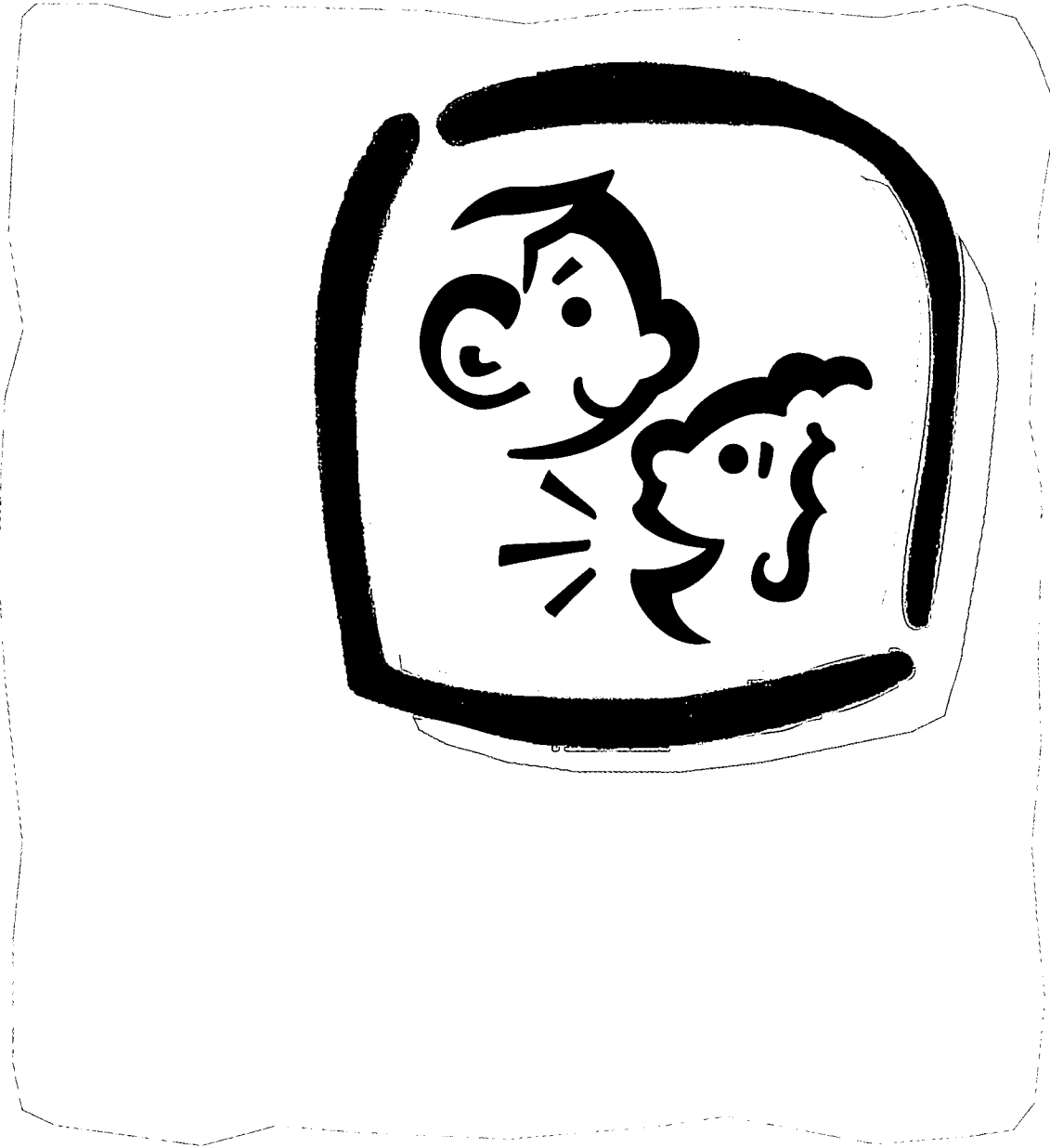



Expectation

Effective communication is essential to workplaces, communities, and families. Communication is critical to personal development in environmental and agricultural careers. Employees with strong communication skills contribute to organizational productivity, enhance interpersonal relationships with coworkers and clients, and create opportunities for promotion and advancement.

Competencies

2.1 Communicate using telecommunication tools

2.2 Conduct meetings and other group functions

2.3 Deliver business presentations

Scenario

You are a new Agricultural Education teacher who has been hired to develop a new secondary Agricultural Education program. The Board of Education specifically hired a new professional to ensure the program will be contemporary. Currently, the program only has a facility, but no equipment or instructional resources. Over the next year, the Board of Education is expecting you to develop and implement a state-approved program based on the needs of the community as determined by a local advisory committee. You will also be expected to handle recruitment, promoting your program to potential students. The Board of Education expects you to provide written monthly reports and oral presentations, as appropriate, as you develop the program.

Guiding Questions

- What do you need to know about the local community to make decisions about your program? How will you find that information?
- What procedures should be followed to establish advisory committee meetings?
- What laws and regulations must be followed to develop a state-approved program?
- How will you present your work progress to the board, orally and in writing?

BEST COPY AVAILABLE



Core ITAC	Competency Connections
Strand 1: Solving Problems and Thinking Skillfully	1.1, 1.2
Strand 2: Communicating Effectively	2.1, 2.2, 2.3, 2.5, 2.6, 2.11
Strand 3: Applying Technology	3.1, 3.2, 3.3
Strand 4: Working Responsibly	4.1, 4.2, 4.3, 4.5
Strand 5: Planning and Managing a Career	None
Strand 6: Managing Resources	6.1, 6.2

Academic Connections

	Social Studies	<ul style="list-style-type: none"> • World Interactions: Analyze the impact of technology on communication and transportation throughout history in helping to bring the people of the world in closer contact
	Language Arts	<ul style="list-style-type: none"> • Writing/Structure: Refine word choice and tone according to audience, situation, and purpose • Writing/Meaning Construction: Evaluate, analyze, and synthesize information for writing • Listening/Visual Literacy: Use technology and other media as a means of expressing ideas • Oral Communication/Structure: Refine speaking techniques for formal, semiformal, and informal settings • Oral Communication/Meaning Construction: Communicate orally to inform and persuade • Oral Communication/Meaning Construction: Prepare a formal speech/presentation • Oral Communication/Application: Use oral communication for a variety of purposes and audiences (e.g., negotiation, book reviews, rationales)
	Foreign Language	<ul style="list-style-type: none"> • Cultural Knowledge: Interact in a variety of cultural contexts that reflect both peer-group and adult activities of the target culture(s) using appropriate verbal and nonverbal language • Insights into the Nature of Language and Culture: Develop the ability to paraphrase and circumlocute to facilitate communication in the target language

BEST COPY AVAILABLE



Academic Connections



Science

- **Scientific Inquiry:** Communicate the results of investigations clearly in a variety of situations
- **Conditions for Learning Science:** Present the results of investigations in a variety of forums
- **Conditions for Learning Science:** Present persuasive argument based on the scientific aspects of controversial issues
- **Conditions for Learning Science:** Keep journals of observations and inferences made over an extended period of time, and reflect upon the impact of these recorded ideas on own thinking and actions
- **Conditions for Learning Science:** Conduct formal scientific debates in the classroom
- **Conditions for Learning Science:** Listen attentively and critically to presentations of scientific information made by others
- **Applications for Science Learning:** Use technology to collect, analyze, and communicate information (e.g., electronic networks, desktop publishing, remote sensing, graphing calculators, satellite telemetry)



Competencies & Key Indicators

2.1 Communicate using telecommunication tools

- | | |
|-----------------|--|
| Key Indicators: | <ul style="list-style-type: none"> 2.1.1 Identify facility/agency policies and protocols regarding use of telecommunications tools (telephones, answering machine, voice mail, e-mail, teleconferencing systems, Internet) 2.1.2 Apply needed operating information using manufacturer's manuals 2.1.3 Place/receive phone calls in accordance with established policies/protocols 2.1.4 Communicate via intercom in accordance with established policies/protocols 2.1.5 Communicate via voice mail in accordance with established policies/protocols 2.1.6 Communicate via e-mail in accordance with established policies/protocols 2.1.7 Communicate via teleconferencing system in accordance with established policies/protocols 2.1.8 Take complete and accurate messages 2.1.9 Give complete and accurate messages 2.1.10 Keep up-to-date concerning new and emerging communication technologies 2.1.11 Select communication method appropriate for specific purpose |
|-----------------|--|

2.2 Conduct meetings and other group functions

- | | |
|-----------------|---|
| Key Indicators: | <ul style="list-style-type: none"> 2.2.1 Identify types and purposes of meetings 2.2.2 Plan meetings 2.2.3 Apply parliamentary procedure 2.2.4 Schedule meetings 2.2.5 Prepare agendas 2.2.6 Make necessary meeting room arrangements 2.2.7 Make arrangements for participants' special needs (dietary needs, hearing needs, handicap access, foreign language interpreter) 2.2.8 Facilitate meetings 2.2.9 Participate in group discussions and meetings 2.2.10 Communicate roles and responsibilities of committee members and officers 2.2.11 Analyze effectiveness of meetings |
|-----------------|---|

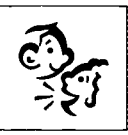

- 2.3
- 2.3.1
- 2.3.2
- 2.3.3
- 2.3.4
- 2.3.5
- 2.3.6
- 2.3.7
- 2.3.8
- 2.3.9
- 2.3.10

Key Indicators:

Deliver business presentations

- Identify types and purposes of presentations for business use
- Evaluate audience and demographic variables
- Gather information for presentations
- Develop presentation outlines
- Compose presentations
- Prepare presentation materials
- Enhance presentation delivery using various types of technology
- Deliver various types of business presentations
- Project a professional business image (appearance, voice, grammar, word usage, enunciation, nonverbal communication)
- Analyze effectiveness of presentations

BEST COPY AVAILABLE

Applying Technology - Strand

3

.....
Environmental & Agricultural Systems Career Cluster ITAC

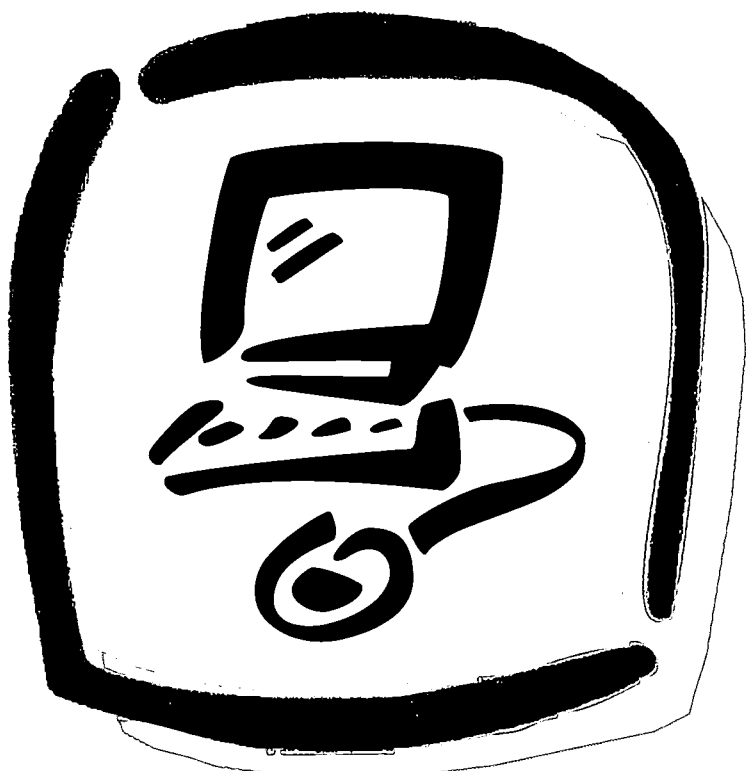



Expectation

Technology influences every work environment. To be effective in environmental and agricultural industries today, individuals must be able to analyze mechanical systems and use the tools of technology to improve productivity and efficiency. Employers seek individuals who have developed technological skills and who stay abreast of the continuously changing technological environment.

Competencies

- | | |
|--|---|
| 3.1 Measure environmental and agricultural objects using standard and metric systems | 3.7 Apply basic concrete construction skills |
| 3.2 Operate hand and power tools and equipment | 3.8 Apply basic plumbing skills |
| 3.3 Identify the principles of transmission of mechanical power in mechanical systems | 3.9 Install basic electrical circuits |
| 3.4 Apply basic methods of joining metal components | 3.10 Analyze electric power systems |
| 3.5 Apply basic wood construction skills | 3.11 Analyze engine power systems |
| 3.6 Apply basic plastic construction skills (e.g., fencing, plumbing, greenhouse construction) | 3.12 Apply physical principles to mechanical systems |
| | 3.13 Examine the effects of environmental and agricultural technology |
| | 3.14 Manage information using computer applications |

Scenario

You are a manager for an expanding full-service lawn and garden center in a suburban area. The center currently focuses on the lawn care and gardening side of the industry. A major goal of the center is to expand into landscaping and design. To do this effectively, the center will need to construct new facilities to house and repair its new inventory of equipment. You have been assigned to plan and oversee the construction of the new facility. To save money, the owners want selected employees to assist in the construction of the new building. First, you must select an architect to plan a design that will meet the center's needs related to the new inventory. After the plan is designed, you need to select and train the employees to assist in construction. The four owners of the center expect you to present a proposed design and construction plan within two months.

Guiding Questions

- How will you select which architect to work with?
- What criteria will you use to assess the architect's plan?
- What tools and equipment will be needed for construction?
- How will you ensure that employees have the skills to do the job?
- How will you manage the construction of the building?
- How will you incorporate the latest technologies into the facility?



Core ITAC	Competency Connections
Strand 1: Solving Problems and Thinking Skillfully	1.1, 1.2, 1.3, 1.5
Strand 2: Communicating Effectively	2.1, 2.3
Strand 3: Applying Technology	3.1, 3.3, 3.4, 3.5, 3.6
Strand 4: Working Responsibly	4.3, 4.4
Strand 5: Planning and Managing a Career	None
Strand 6: Managing Resources	6.1, 6.2, 6.5, 6.6

Academic Connections



Math

- **Patterns, Relations, and Functions:** Model real-world phenomena with polynomial and exponential functions
- **Geometry:** Represent problem situations with geometric models and apply properties of figures
- **Algebra:** Describe problem situations by using and relating numerical, symbolic, and graphical representations
- **Algebra:** Set up and solve linear equations
- **Algebra:** Describe geometric situations and phenomena using variables, equations, and functions



Language Arts

- **Reading/Application:** Employ various reading strategies according to purpose
- **Listening/Visual Literacy:** Use technology and other media as a means of expressing ideas



Science

- **Scientific Inquiry:** Check the appropriateness and accuracy of measures and computations using various strategies (e.g., estimations, unit analysis, determination of significant figures)
- **Scientific Inquiry:** Construct and test models of physical, biological, social, and geological systems
- **Scientific Inquiry:** Create multiple representations of the same data using a variety of symbols, descriptive languages, mathematical concepts, and graphic techniques
- **Scientific Knowledge:** Formulate estimations for the range of energies within and between various phenomena (e.g., thermal, electromagnetic, thermonuclear, chemical, electrical)
- **Scientific Knowledge:** Formulate estimates for a wide range of measurement and scales (e.g., angstroms to light years)
- **Scientific Knowledge:** Formulate explanations and representations of the production, transmission, and conservation of energy in biological and physical systems (e.g., weather, volcanism, earthquakes, electricity, magnetism, cellular respiration)



Academic Connections



Science (cont.)

- **Scientific Knowledge:** Formulate explanations for the historical development of descriptions of motions, interactions, and transformations of matter and energy (e.g., classical Newtonian mechanics, special and general relativity, chaos)
- **Scientific Knowledge:** Formulate interpretations of the structure, function and diversity in a variety of organisms and physical systems (e.g., DNA and RNA variants, nucleons, interaction particles)
- **Scientific Knowledge:** Formulate specific cases of limitations and possible exceptions of theories and principles regarding the interactions of moving objects and organisms (e.g., fluid flow in vessels, motion near the speed of light, Heisenberg Uncertainty Principle, meteorological prediction, local variation and diversity, earthquake prediction, energy transportation in cellular respiration)
- **Conditions for Learning Science:** Respect the scientific thinking of others and self
- **Applications for Science Learning:** Answer student-determined questions by designing databases and drawing inferences from the analyses of the information in these databases
- **Applications for Science Learning:** Do simple troubleshooting on common electrical and mechanical systems, identifying and eliminating possible causes of malfunctions
- **Applications for Science Learning:** Use technology to collect, analyze, and communicate information (e.g., electronic networks, desktop publishing, remote sensing, graphing calculators, satellite telemetry)



Competencies & Key Indicators

3.1 **Measure environmental and agricultural objects using standard and metric systems**

- Key Indicators:
- 3.1.1 Identify units of length, volume, mass, and temperature
 - 3.1.2 Determine surface area of land and physical structures
 - 3.1.3 Determine weights of agricultural and environmental products
 - 3.1.4 Determine volume of structures containing solids and/or liquids
 - 3.1.5 Measure air and water temperatures

3.2 **Operate hand and power tools and equipment**

- Key Indicators:
- 3.2.1 Identify standard tools, equipment, and safety procedures
 - 3.2.2 Select tools and equipment
 - 3.2.3 Follow operating instructions
 - 3.2.4 Set up/adjust tools and equipment
 - 3.2.5 Maintain tools
 - 3.2.6 Store tools

3.3 **Identify the principles of transmission of mechanical power in mechanical systems**

- Key Indicators:
- 3.3.1 Identify the role of gears, belts, and pulleys
 - 3.3.2 Identify the role of hydraulic/pneumatic power
 - 3.3.3 Identify the role of levers/fulcrums
 - 3.3.4 Identify the role of inclined planes

BEST COPY AVAILABLE



3.4

Apply basic methods of joining metal components

- 3.4.1
- 3.4.2
- 3.4.3
- 3.4.4
- 3.4.5
- 3.4.6
- 3.4.7
- 3.4.8
- 3.4.9
- 3.4.10
- 3.4.11
- 3.4.12

Key Indicators:

- Identify common types of metals
- Identify the properties of different metals
- Compare/contrast the potential uses of different metals
- Identify the effects of heat on metals
- Weld metals
- Solder/braze metal components
- Fabricate cold metal
- Identify common types of fasteners for assembling metal components
- Select types of fasteners appropriate for a given assembly task
- Assemble a project involving metal components
- Repair a project involving metal components
- Cut metals

3.5

Apply basic wood construction skills

- 3.5.1
- 3.5.2
- 3.5.3
- 3.5.4
- 3.5.5
- 3.5.6
- 3.5.7

Key Indicators:

- Identify the structural properties, grades, and types of wood and wood products
- Identify types of fasteners used in wood construction
- Select types of fasteners appropriate for a given assembly task
- Prepare wood surfaces for taking a finish
- Select appropriate finishes for wood products
- Apply wood finishes
- Assemble/repair projects involving wood components

3.6

Apply basic plastic construction skills (e.g. fencing, plumbing, greenhouse construction)

- 3.6.1
- 3.6.2
- 3.6.3
- 3.6.4

Key Indicators:

- Identify the structural properties of different types of plastics
- Cut plastic components
- Shape plastic components
- Assemble plastic components



3.7

Apply basic concrete construction skills

3.7.1

Identify the composition of concrete

3.7.2

Determine the chemical reactions in the curing process

3.7.3

Construct forms

3.7.4

Mix concrete

3.7.5

Place concrete

3.7.6

Reinforce concrete

3.7.7

Finish concrete

Key Indicators:

3.8

Apply basic plumbing skills

3.8.1

Identify the major components of water supply and wastewater systems

3.8.2

Identify the major kinds of materials used in plumbing

3.8.3

Compare/contrast materials used in plumbing components

3.8.4

Calculate system requirements

3.8.5

Fabricate plumbing

Key Indicators:

3.9

Install basic electrical circuits

3.9.1

Apply the theory of electrical flow

3.9.2

Identify components of common branch circuits

3.9.3

Compare/contrast conductors

3.9.4

Evaluate series and parallel circuits

3.9.5

Compare/contrast AC and DC electrical systems

3.9.6

Calculate service requirements

3.9.7

Determine rate of electricity usage

3.9.8

Replace circuit protection devices

3.9.9

Assemble branch circuits

Key Indicators:

3.10

Analyze electric power systems

3.10.1

Demonstrate knowledge of the operating principles of electric motors

3.10.2

Compare various motors and their uses

3.10.3

Identify alternative power sources (e.g., solar, wind, water)

Key Indicators:



3.11

Analyze engine power systems

3.11.1

Demonstrate knowledge of the operating principles of 2-cycle and 4-cycle engines

3.11.2

Identify the functions of fuel/air system components

3.11.3

Identify the functions of ignition system components

3.11.4

Identify the functions of cooling system components

3.11.5

Identify the functions of lubrication system components

3.11.6

Identify general maintenance required on engine systems

Key Indicators:

3.12

Apply physical principles to mechanical systems

3.12.1

Relate the basic principles of fluid and gas mechanics to mechanical systems

3.12.2

Relate the basic principles of motion and friction to mechanical systems

3.12.3

Relate basic thermodynamic principles to mechanical systems

3.12.4

Relate the basic principles of magnetism to electrical systems

3.12.5

Calculate current resistance or voltage using Ohm's law

3.12.6

Demonstrate knowledge of the relationship between heat, light, and electricity

3.12.7

Demonstrate knowledge of the relationship between power, torque, and speed

Key Indicators:

3.13

Examine the effects of environmental and agricultural technology

3.13.1

Identify the major trends in technology

3.13.2

Identify the major implications of technology for producers and consumers

3.13.3

Identify the social implications of technology

3.13.4

Identify the immediate and future impacts of technology on agricultural and environmental industries

Key Indicators:

3.14

Manage information using computer applications

3.14.1

Access operating information using reference materials

3.14.2

Process work using a software program

3.14.3

Perform record keeping using a software program appropriate to the task

3.14.4

Access current information via the Internet

Key Indicators:

BEST COPY AVAILABLE

Working Responsibly - Strand

4

.....
Environmental & Agricultural Systems Career Cluster ITAC



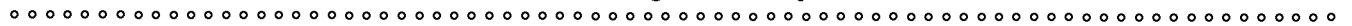

Expectation

Working responsibly encompasses skills in citizenship, community awareness, and management. Individuals must daily demonstrate a strong work ethic, including—but not limited to—honesty, initiative, and dependability. Individuals must be able to discern between right and wrong in difficult or subtle situations. Then, they must act with rightness, fairness, and equity. Individuals must be free from petty, mean, or dubious conduct if an organization is to thrive. Without high standards of ethical conduct on both sides, individuals and organizations are subject to low morale and a host of management, legal, economic, and political problems.

Competencies

- | | | | |
|-----|--|-----|-----------------------------|
| 4.1 | Identify significant environmental and agricultural issues | 4.2 | Apply citizenship skills |
| | | 4.3 | Improve community awareness |

Scenario

You are a food-processing quality-control employee for a major food manufacturer. There has been a recent rise in the number of food-borne illnesses and deaths (Lysteria, E.coli) in your state. Recently, your company recalled over 10,000 pounds of product that may be related to a food-related illness. The local agricultural broadcasting network has asked to interview you on the impact of the potential illnesses and what precautions your company is taking to protect its customers from harm. Your immediate supervisor has asked you to prepare an outline that will assist you and the journalist with the interview.

Guiding Questions

- What are the company’s legal and ethical responsibilities?
- What would be the consequences to the company and industry for behaving unethically?
- How will you determine what the community needs to know about the food-borne illnesses?
- What plan of action will your company develop to address the issue at hand and to show the company’s responsibility to the community?



Core ITAC	Competency Connections
Strand 1: Solving Problems and Thinking Skillfully	1.1, 1.2
Strand 2: Communicating Effectively	2.1, 2.2, 2.3, 2.5, 2.11
Strand 3: Applying Technology	None
Strand 4: Working Responsibly	4.1, 4.3, 4.4, 4.6
Strand 5: Planning and Managing a Career	None
Strand 6: Managing Resources	6.1, 6.2

Academic Connections



Social Studies

- **American Heritage:** Identify significant developments in history, and gauge their impact on subsequent events
- **American Heritage:** Draw connections between ideas, interests, beliefs, and ideologies and their influence on individual and group historical actions
- **American Heritage:** Identify key historical events, and explain their impact on subsequent developments
- **World Interactions:** Utilize a variety of references to analyze and develop plausible explanations for historic and current events
- **World Interactions:** Describe human modifications of the physical environment that have had intended, as well as unintended, effects; and consider alternative approaches to dealing with the environment
- **Democratic Processes:** Justify proposed solutions to current issues by explaining how they adhere to democratic principles
- **Citizenship Rights and Responsibilities:** Acquire, interpret, and analyze information regarding civic issues; evaluate the reliability of available information; identify and weigh alternative viewpoints
- **Citizenship Rights and Responsibilities:** Explain why it is important for citizens to participate in the public policy process
- **Citizenship Rights and Responsibilities:** Analyze the impact of citizen participation on significant issues
- **Citizenship Rights and Responsibilities:** Identify and critique the responsibilities of citizenship in a democratic society
- **Citizenship Rights and Responsibilities:** Evaluate voluntary efforts in terms of what citizens gain and contribute and their effects on the common welfare
- **Citizenship Rights and Responsibilities:** Work as an individual or as part of a group on a significant issue

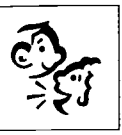

Academic Connections



Science

- **Scientific Inquiry:** Examine relationships in nature, offer alternative explanations for the observations, and collect evidence that can be used to help judge among explanations
- **Scientific Knowledge:** Investigate physical and chemical changes in living and nonliving systems (e.g., photosynthesis, weathering processes, glaciation, thermal effects on materials, energy cells)
- **Conditions for Learning Science:** Study and propose improvements in public services and systems in own community
- **Conditions for Learning Science:** Lead multi-age groups in the examination of and planned resolution for scientific issues
- **Applications for Science Learning:** Predict various scenarios and propose solutions to community issues using scientific information (e.g., actuarial tables, census data, topographic maps, incidence data, climatic data)



Competencies & Key Indicators

4.1

Identify significant environmental and agricultural issues

4.1.1
4.1.2
4.1.3
4.1.4

Key Indicators:

- Identify the interrelationships between agriculture and the environment
- Research the history of environmental issues, regulations, and uses of natural resources
- Identify choices that reflect responsible and irresponsible uses of the natural environment
- Forecast issues for the environmental and agricultural industries

4.2

Apply citizenship skills

4.2.1
4.2.2
4.2.3
4.2.4
4.2.5
4.2.6

Key Indicators:

- Recognize the importance of leadership to citizenship
- Recognize the importance of leadership, volunteerism, and community service to citizenship
- Assess the value of leadership, volunteerism, and community service
- Identify leadership qualities
- Identify the qualities of a responsible volunteer
- Participate in leadership, volunteerism, and community service opportunities

4.3

Improve community awareness

4.3.1
4.3.2
4.3.3
4.3.4
4.3.5
4.3.6
4.3.7
4.3.8

Key Indicators:

- Determine community needs
- Identify community service projects
- Identify facility/agency policies and protocols
- Develop agricultural awareness in the community
- Develop community's awareness of agricultural education history
- Develop community's awareness of agricultural youth organization history
- Identify impacts of environmental and agricultural organizations on the community
- Identify governmental structures within the community

BEST COPY AVAILABLE



Environmental & Agricultural

Environmental & Agricultural

Planning and Managing a Career - Strand

5

.....
Environmental & Agricultural Systems Career Cluster ITAC

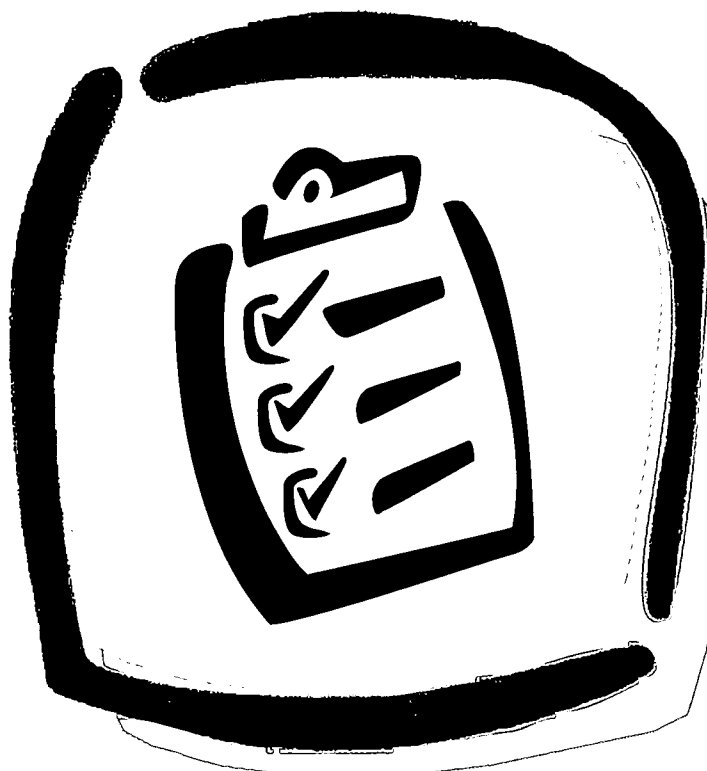



Expectation

Since work is a significant part of life, individuals need to be actively engaged in seeking a career that matches their interests, abilities, aptitudes, and skills. Career planning enhances the possibility that one's career path will lead to success and satisfaction in work. Employers seek individuals who know what they want from work and can effectively present their qualifications and skills through the job search process, including job applications and interviews. Throughout one's career, it is also important to seek continuous professional development opportunities.

Competencies

- | | | | |
|-----|---|-----|-----------------------------------|
| 5.1 | Explore various environmental and agricultural careers | 5.3 | Plan for professional development |
| 5.2 | Seek employment in the environmental or agricultural industries | 5.4 | Manage professional career |

Scenario

You have been working as an animal care technician in a veterinary hospital and are very much interested in advancing your career in the environmental and agriculture industries. Your employer will provide tuition assistance if you establish a plan for your professional development. Explore qualifications for various positions, and develop a plan to meet your career goals. Include a career ladder, education and training opportunities, and a plan for seeking future positions. Present your plan to a panel of employer representatives.



Guiding Questions

- How will you find out about the variety of careers in the environmental and agriculture industries?
- How will you determine your match (interests, attitudes, and abilities) to a career choice?
- After you identify interest in a specific career, how will you find out about educational requirements and training opportunities?
- How will professional organizations impact your career?

BEST COPY AVAILABLE



Core ITAC	Competency Connections
Strand 1: Solving Problems and Thinking Skillfully	1.1, 1.2, 1.3
Strand 2: Communicating Effectively	2.1, 2.2, 2.3, 2.5, 2.6, 2.11
Strand 3: Applying Technology	3.1, 3.3, 3.6
Strand 4: Working Responsibly	4.1
Strand 5: Planning and Managing a Career	5.1, 5.2, 5.3, 5.4, 5.5, 5.6, 5.7
Strand 6: Managing Resources	6.1, 6.2, 6.7, 6.11

Academic Connections	
	<p>Social Studies</p> <ul style="list-style-type: none"> • World Interactions: Describe ways in which natural processes and human activities contribute to global environmental problems • World Interactions: Describe human modifications of the physical environment that have had intended, as well as unintended, effects; and consider alternative approaches to dealing with the environment • Democratic Processes: Analyze governmental actions in the United States federal system on the basis of the fundamental principles of American democracy, and evaluate the extent to which the actions reflect those principles and help to serve the public good • Citizenship Rights and Responsibilities: Evaluate voluntary efforts in terms of what citizens gain and contribute and their effects on the common wealth
	<p>Language Arts</p> <ul style="list-style-type: none"> • Writing/Structure: Refine word choice and tone according to audience, situation, and purpose • Writing/Meaning Construction: Evaluate, analyze, and synthesize information for writing • Writing/Meaning Construction: Use word processing, graphics, and publishing as aids for constructing meaning in writing • Oral Communication/Structure: Refine speaking techniques for formal, semiformal, and informal settings • Oral Communication/Meaning Construction: Use interviewing techniques to gather information • Oral Communication/Application: Practice interviewing techniques
	<p>Science</p> <ul style="list-style-type: none"> • Applications for Science Learning: Refine personal career interests

BEST COPY AVAILABLE



Competencies & Key Indicators

5.1

Explore various environmental and agricultural careers

5.1.1

Define the major divisions within the environmental and agricultural industries

5.1.2

Demonstrate knowledge of traditional and nontraditional career paths

5.1.3

Evaluate the economic and social importance of various agricultural and environmental industries

5.1.4

Identify various educational requirements and available options for different environmental and agricultural professions

5.1.5

Explore specific environmental and agricultural interests (e.g., through shadowing, worksite experiences)

5.1.6

Research projected growth of various environmental and agricultural careers

5.1.7

Evaluate the status of international careers in the environment and agricultural industries

Key Indicators:

5.2

Seek employment in the environmental or agricultural industries

5.2.1

Identify education and experience needed for obtaining an environmental or agricultural position

5.2.2

Identify documentation needed for obtaining an environmental or agricultural position

5.2.3

Compile documents needed in obtaining a position

5.2.4

Update documents needed for environmental or agricultural employment

5.2.5

Identify employment opportunities

5.2.6

Dress appropriately for job interview

5.2.7

Present credentials, philosophy, and goals in job interview for an environmental or agricultural employment position

5.2.8

Analyze personnel policies and procedures

5.2.9

Identify the process to follow in changing your employment position

5.2.10

Identify laws related to employment in the environmental and agricultural industries

Key Indicators:

BEST COPY AVAILABLE



5.3

Plan for professional development

5.3.1

Identify professional development opportunities and requirements within the agency

5.3.2

Identify the role of professional organizations in the professional development process

5.3.3

Identify the purpose and benefits of belonging to professional organizations within the environmental and agricultural field (membership, networking)

5.3.4

Identify the benefits of belonging to civic and community organizations

5.3.5

Identify the benefits of lifelong learning for the environmental and agricultural field

5.3.6

Determine professional development needs and resources

5.3.7

Develop a plan for meeting professional development needs

Key Indicators:

5.4

Manage professional career

5.4.1

Set professional goals

5.4.2

Plan for career growth

5.4.3

Develop the skills and characteristics needed to meet professional goals

5.4.4

Identify possible advancement patterns in environmental and agricultural careers

5.4.5

Monitor progress toward professional goals

Key Indicators:

BEST COPY AVAILABLE



BEST COPY AVAILABLE

Managing Resources - Strand

6

.....
Environmental & Agricultural Systems Career Cluster ITAC

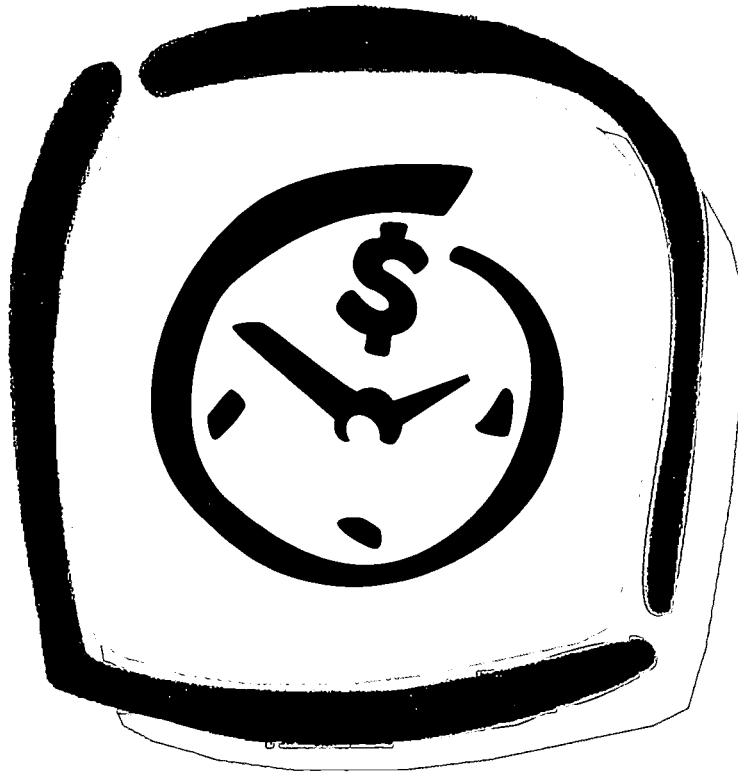

BEST COPY AVAILABLE



Expectation

Individuals working in environmental and agricultural industries are expected to be sound managers of resources. All industries in the environmental and agricultural sectors require sound management of air, water, soil, and life systems. Any career associated with the production and processing of animals and crops or the maintenance of natural biosystems and fabricated ornamental landscapes requires knowledge and skills in the fundamental areas of physiology, health, genetics, and nutrition. The ability to manage enterprise resources directly contributes to the success of the organization or business.

Competencies

- | | | | |
|------|---|------|---|
| 6.1 | Maintain safe work environment | 6.12 | Determine conditions affecting seed germination and seedling growth |
| 6.2 | Maintain safe work habits | 6.13 | Determine plant nutrient requirements |
| 6.3 | Maintain records | 6.14 | Compare pest-management choices |
| 6.4 | Manage economic, environmental, and human resources | 6.15 | Differentiate animals |
| 6.5 | Assess air quality | 6.16 | Relate animal genetics to reproduction and improvement |
| 6.6 | Assess water quality | 6.17 | Determine animal nutritional requirements |
| 6.7 | Determine soil characteristics and uses | 6.18 | Maintain a healthy animal |
| 6.8 | Apply soil management principles | 6.19 | Select harvesting methods |
| 6.9 | Differentiate plants | 6.20 | Select crop-processing methods |
| 6.10 | Relate plant genetics to reproduction and improvement | 6.21 | Evaluate marketing choices |
| 6.11 | Relate plant functions to growth processes and management practices | 6.22 | Determine facility requirements |
| | | 6.23 | Apply food safety principles |

BEST COPY AVAILABLE



Scenario

You are an agronomist who has been hired by a local farmer to develop a cropping plan for the upcoming year and to help improve yields. According to the farmer, past performance has been below area averages. You suspect that the farmer has been using the same practices used by the family for the past 30 years. With exceedingly low commodity prices, the farmer has begun to feel a financial strain in the past two years. Once you have analyzed the farmer's land and farming methods, you need to present to the farmer your recommendations for cropping and improving yield, both orally and in writing.

Guiding Questions

- How will you assess the farmer's land?
- How will you discover the farmer's current methods?
- What criteria will you use to determine your recommendations?
- What information will you include in your recommendations?

BEST COPY AVAILABLE



Core ITAC	Competency Connections
Strand 1: Solving Problems and Thinking Skillfully	1.1, 1.2, 1.3, 1.9, 1.10
Strand 2: Communicating Effectively	None
Strand 3: Applying Technology	None
Strand 4: Working Responsibly	4.1, 4.2, 4.3, 4.4
Strand 5: Planning and Managing a Career	None
Strand 6: Managing Resources	6.1, 6.2, 6.4, 6.5, 6.8, 6.9

Academic Connections



Language Arts

- **Reading/Structure:** Develop and use an increasingly sophisticated vocabulary gained through context
- **Reading/ Meaning Construction:** Confirm and extend meaning in reading by researching new concepts and facts
- **Writing/Structure:** Refine word choice and tone according to audience, situation, and purpose
- **Writing/Meaning Construction:** Evaluate, analyze, and synthesize information for writing
- **Writing/Application:** Vary styles and formats for the intended purpose and audience



Science

- **Scientific Inquiry:** Translate information from and represent information in various forms with equal ease (e.g., tables, charts, graphs, diagrams, geometric figures)
- **Scientific Inquiry:** Design investigations that are safe and ethical (e.g., obtain consent and inform others of potential outcomes, risks, and benefits; and show evidence of concern for human health and safety, concern for nonhuman species)
- **Scientific Inquiry:** Examine relationships in nature, offer alternative explanations for the observations, and collect evidence that can be used to help judge among explanations
- **Scientific Inquiry:** Document potentially hazardous conditions and associated risks in selected homes and public areas
- **Scientific Inquiry:** Formulate taxonomic schemes based upon multivariate models that help to explain similarities and differences in form, distribution, behavior, survival, and origin of objects and organisms
- **Scientific Knowledge:** Investigate various types of dynamic equilibrium (e.g., biological, geological, mechanical, chemical)
- **Scientific Knowledge:** Investigate patterns in the natural world (e.g., heredity, crystalline structures, population and resource distributions, diffraction, dispersion, polarization)



Academic Connections



Science (cont.)

- **Scientific Knowledge:** Formulate models and hypotheses for patterns in the natural world (e.g., earth structures, transportation systems, migrations, communications, constellations)
- **Scientific Knowledge:** Investigate degrees of kinship among organisms and groups of organisms
- **Scientific Knowledge:** Investigate physical and chemical changes in living and nonliving systems (e.g., photosynthesis, weathering processes, glaciation, thermal effects on materials, energy cells)
- **Scientific Knowledge:** Formulate interpretations of the structure, function, and diversity in a variety of organisms and physical systems (e.g., DNA and RNA variants, nucleons, interaction particles)
- **Scientific Knowledge:** Formulate hypotheses and models that may account for observable events (e.g., electricity and magnetism, gravitation, atoms, bonding, chemical reactions, quantum effects, energy flow in biological systems, predator-prey relationships)
- **Scientific Knowledge:** Formulate limitations and refinements of standard classification systems (e.g., periodic table, IUPAC, Linnean, standard model)
- **Scientific Knowledge:** Formulate interpretations of the historical development of various theories of possible causes of diversity among physical and biological phenomena (e.g., the works of Aristotle, Mendel, Darwin, McClintock)
- **Conditions for Learning Science:** Participate actively in dialogue about and resolution of community issues
- **Conditions for Learning Science:** Select and utilize resources by various criteria (e.g., efficiency, effectiveness, health, safety) that are appropriate to the investigations being conducted by groups
- **Conditions for Learning Science:** Keep journals of observations and inferences made over an extended period of time, and reflect upon the impact of these recorded ideas on own thinking and actions
- **Applications for Science Learning:** Investigate the functionality of various geometric shapes in the natural world and the designed world (e.g., translations from spherical to plane representations cause distortions, triangular shapes contribute to rigidity and stability in structures, round shapes minimize boundary for a given capacity)
- **Applications for Science Learning:** Choose consumer materials utilizing personal and environmental risk and benefit information
- **Applications for Science Learning:** Make decisions regarding personal and public health
- **Applications for Science Learning:** Develop and write environmental impact, and safety and hygiene management plans
- **Applications for Science Learning:** Identify and reduce risks and threats to a sustainable environment



Academic Connections



Science
(cont.)

- **Applications for Science Learning:** Research and write environmental impact statements of own design
- **Applications for Science Learning:** Design management plans for natural and human-altered environments (e.g., woodlots, patios, lots, lawns, farmlands, forests)
- **Applications for Science Learning:** Make informed consumer choices by evaluating and prioritizing information, evidence, and strategies



Competencies & Key Indicators

6.1

Maintain safe work environment

- 6.1.1 Identify types of safety equipment (e.g., fire blanket, extinguisher types, shields, eye protection)
- 6.1.2 Demonstrate knowledge of how to use safety equipment
- 6.1.3 Identify agricultural and environmental safety hazards
- 6.1.4 Identify hazardous agricultural and environmental materials (e.g., pesticides, herbicides, fertilizers, petroleum, heavy metals)
- 6.1.5 Keep up-to-date with sources of information about agricultural and environmental issues pertaining to industry (e.g., Health Administration, Environmental Protection Agency [EPA], Food and Drug Administration [(FDA), and state and federal regulations)
- 6.1.6 Follow established emergency plans (e.g., for leakage of agricultural chemicals, loose animals)
- 6.1.7 Maintain work areas (e.g., animal housing, food processing, construction areas) in accordance with standards for cleanliness and safety
- 6.1.8 Comply with agricultural job-site safety-zone rules
- 6.1.9 Comply with agricultural equipment safety rules

Key Indicators:

6.2

Maintain safe work habits

- 6.2.1 Follow label information (e.g., use of pesticides, herbicides, animal medications, cleaners)
- 6.2.2 Identify the components of basic first aid
- 6.2.3 Wear job-appropriate agricultural and environmental protective clothing and equipment
- 6.2.4 Employ safe lifting and carrying methods
- 6.2.5 Interpret agricultural and environmental safety signs and symbols (e.g., slow-moving-vehicle signs, PTO, flammable)
- 6.2.6 Follow procedures for personal cleanup

Key Indicators:

6.3

Maintain records

- 6.3.1 Select record-keeping strategies
- 6.3.2 Identify purposes of maintaining records
- 6.3.3 Complete record components
- 6.3.4 Evaluate efficiency measures
- 6.3.5 Implement record-keeping system

Key Indicators:

BEST COPY AVAILABLE



6.4

Manage economic, environmental, and human resources

6.4.1

Allocate resources

6.4.2

Prioritize goal-related activities

6.4.3

Allocate time to activities

6.4.4

Follow established schedules

6.4.5

Identify sources of capital

6.4.6

Forecast future budgetary needs

6.4.7

Analyze financial statements

Key Indicators:

6.5

Assess air quality

6.5.1

Identify the major components of air

6.5.2

Analyze impact of air quality for humans and other living organisms

6.5.3

Analyze the relationship between environmental factors and air quality

6.5.4

Determine characteristics of clean air

6.5.5

Identify air quality standards

6.5.6

Identify common threats to air quality and their effects

6.5.7

Identify practices that lead to improved air quality

6.5.8

Conduct air quality tests

6.5.9

Demonstrate knowledge of wind direction and wind speed

Key Indicators:

6.6

Assess water quality

6.6.1

Analyze the relationships between natural environmental factors and water quality

6.6.2

Analyze impact of water quality for humans and other living organisms

6.6.3

Determine characteristics of water (e.g., hardness, temperature, pH)

6.6.4

Identify water quality standards

6.6.5

Identify practices affecting surface water quality

6.6.6

Identify factors affecting groundwater quality

6.6.7

Demonstrate knowledge of the hydrologic cycle

6.6.8

Identify common threats to water quality and their effects

6.6.9

Compare/contrast techniques for conserving water

6.6.10

Conduct water quality tests

Key Indicators:



Determine soil characteristics and uses

6.7

Key Indicators:

- 6.7.1 Demonstrate knowledge of the major soil horizons
- 6.7.2 Calculate land slope
- 6.7.3 Determine texture
- 6.7.4 Determine drainage
- 6.7.5 Identify erodability
- 6.7.6 Interpret soil survey maps
- 6.7.7 Identify organic matter content

Apply soil management principles

6.8

Key Indicators:

- 6.8.1 Identify land capability classifications
- 6.8.2 Select major soil and water conservation practices
- 6.8.3 Select Best Management Practices (BMP)
- 6.8.4 Conduct soil tests
- 6.8.5 Identify types of erosion
- 6.8.6 Demonstrate knowledge of farmland preservation techniques and issues

Differentiate plants

6.9

Key Indicators:

- 6.9.1 Differentiate between woody and herbaceous plants
- 6.9.2 Differentiate between evergreen and deciduous plants
- 6.9.3 Classify plants as monocots or dicots
- 6.9.4 Classify plants as annuals, biennials, or perennials
- 6.9.5 Identify plants according to common and scientific names
- 6.9.6 Identify the major crops within the agronomic plant groups
- 6.9.7 Identify the major crops within the horticultural plant groups

Relate plant genetics to reproduction and improvement

6.10

Key Indicators:

- 6.10.1 Identify the relationship between reproduction and plant improvement
- 6.10.2 Identify dominant and recessive genes
- 6.10.3 Differentiate between hereditary and nonhereditary traits
- 6.10.4 Compare/contrast heritability and environmental effects on plant reproduction
- 6.10.5 Trace the development of plant varieties through sexual reproduction
- 6.10.6 Trace the development of plant varieties through asexual reproduction



6.11

Relate plant functions to growth processes and management practices

6.11.1

Match plant structures to their functions

6.11.2

Relate the absorption process to growth and management

6.11.3

Relate the photosynthesis process to growth and management

6.11.4

Compare/contrast the respiration and transpiration processes

6.11.5

Identify methods for managing water

6.11.6

Identify methods for managing light

6.11.7

Identify methods for managing temperature

6.11.8

Identify methods for managing air

6.11.9

Manage growth mediums (soil and soil-less)

Key Indicators:

6.12

Determine conditions affecting seed germination and seedling growth

6.12.1

Identify the role of seed parts in seed germination and seedling growth

6.12.2

Determine the effect of seed quality on germination

6.12.3

Conduct seed germination tests

6.12.4

Analyze the influence of environmental conditions on seed germination and seedling growth

6.12.5

Identify management practices that enhance seed germination and seedling growth

Key Indicators:

6.13

Determine plant nutrient requirements

6.13.1

Identify nutrient requirements

6.13.2

Interpret chemical symbols

6.13.3

Classify nutrients

6.13.4

Identify nutrient functions

6.13.5

Identify major plant nutritional deficiencies

6.13.6

Identify sources of inorganic and organic nutrients

6.13.7

Identify the components of a fertilizer label

6.13.8

Identify the effects of nutrient functions on plant growth

6.13.9

Demonstrate knowledge of plant nutrient absorption

6.13.10

Conduct plant tissue tests

Key Indicators:



6.14

Compare pest-management choices

6.14.1

Identify major types of insects, beneficial and nonbeneficial

6.14.2

Identify the categories of damage done by pests

6.14.3

Identify common types of weeds and their methods of germination

6.14.4

Identify major types of crop diseases and the associated plant symptoms

6.14.5

Identify major types of biological and mechanical controls

6.14.6

Compare plant and pest life cycles as they relate to control measures

6.14.7

Interpret chemical labels and compatibility charts

6.14.8

Handle nonrestricted chemicals in accordance with chemical use regulations

6.14.9

Implement nonchemical control measures

6.14.10

Develop an Integrated Pest Management (IPM) program

Key Indicators:

6.15

Differentiate animals

6.15.1

Classify animals (e.g., classifications, breeds, species)

6.15.2

Analyze performance records and pedigrees

6.15.3

Identify major external body characteristics and their functions

6.15.4

Compare animal digestive systems

Key Indicators:

6.16

Relate animal genetics to reproduction and improvement

6.16.1

Compare breeding systems in relation to animal improvement

6.16.2

Identify major reproductive organs and their functions

6.16.3

Identify dominant and recessive traits

6.16.4

Identify heredity principles

6.16.5

Trace the estrus cycle

6.16.6

Determine gestation/incubation periods

6.16.7

Determine sex

6.16.8

Determine the influence of genetics on animal productivity

6.16.9

Determine desirable characteristics for offspring

Key Indicators:

BEST COPY AVAILABLE



6.17

Determine animal nutritional requirements

6.17.1

Compare animal digestive systems

6.17.2

Determine nutrient requirements for growth and maintenance

6.17.3

Identify nutrient classes and sources

6.17.4

Identify the role of feed additives

6.17.5

Develop a balanced diet

6.17.6

Select feeding and watering practices and systems

6.17.7

Identify major nutrient deficiency symptoms

6.17.8

Identify growth-enhancement technologies

Key Indicators:

6.18

Maintain a healthy animal

6.18.1

Identify major integumentary system components and functions (e.g., skin, feathers, wool, scales)

6.18.2

Identify major urinary system components and functions

6.18.3

Identify major respiratory system components and functions

6.18.4

Identify major internal and external pests

6.18.5

Recognize signs of good and poor animal health

6.18.6

Recognize symptoms of diseases

6.18.7

Determine methods of preventing health problems and parasites

6.18.8

Determine methods of treating health problems

6.18.9

Outline the components of an animal Integrated Pest Management (IPM) program

6.18.10

Determine how to implement quality assurance

6.18.11

Identify environmental assurance standards

Key Indicators:

6.19

Select harvesting methods

6.19.1

Compare calculated yields with production standards

6.19.2

Identify characteristics of crop maturity

6.19.3

Identify external factors that influence time of harvest

6.19.4

Identify harvest indicators

6.19.5

Evaluate crop storage choices

6.19.6

Identify crop characteristics needed for safe storage

Key Indicators:



6.20

Select crop-processing methods

- 6.20.1
- 6.20.2
- 6.20.3
- 6.20.4
- 6.20.5

Key Indicators:

- Identify safety techniques related to crop-processing
- Determine crop quality
- Identify grade standards
- Identify federal grading regulations
- Examine processing methods

6.21

Evaluate marketing choices

- 6.21.1
- 6.21.2
- 6.21.3
- 6.21.4
- 6.21.5
- 6.21.6

Key Indicators:

- Identify markets
- Identify factors that influence supply and demand
- Develop a marketing strategy
- Determine market grades and standards
- Identify factors that influence market standards and/or grade
- Examine types of product packaging and how each is perceived by consumers

6.22

Determine facility requirements

- 6.22.1
- 6.22.2
- 6.22.3
- 6.22.4
- 6.22.5
- 6.22.6
- 6.22.7

Key Indicators:

- Calculate space requirements
- Select methods of managing nutrition and water
- Select methods of managing light
- Select methods of managing air and temperature
- Determine shelter requirements
- Select methods/systems of waste management
- Identify governmental regulation agencies (e.g., OSHA, EPA) related to facility requirements

6.23

Apply food safety principles

- 6.23.1
- 6.23.2
- 6.23.3
- 6.23.4

Key Indicators:

- Select safe storage practices
- Select safe product-handling practices
- Comply with safe practices for eliminating chemicals from products
- Identify Hazardous Analysis Critical Control Points (HACCP)

BEST COPY AVAILABLE

Environmental & Agricultural Systems Career Cluster ITAC Acknowledgments

The Vocational Instructional Materials Laboratory extends thanks and appreciation to the many representatives of business, industry, labor, and community organizations who contributed their time and expertise to the identification and verification of competencies.

The following panel participants verified the technical and academic competencies in the Environmental and Agricultural Career Cluster ITAC:

Tim Barney, The Andersons, Delta, Ohio
Robyn Radway Calliccoat, Ohio Pork Producers and Consumer Science, Columbus, Ohio
John A. Collet, Farmland Industries, Delaware, Ohio
Steve Hawkins, Ohio Dept. of Natural Resources, Circleville, Ohio
Don E. Loudenslager, Private Farmer, Morral, Ohio
Susie Schmidt, Jack's Aquarium and Pets, Columbus, Ohio
Cory Skurdal, Ohio Nursery and Landscape Association, Westerville, Ohio
Andrew Stevens, Magnet Communications, Ostrander, Ohio
Don Van Nostran, Mid-States Wool Growers Cooperative, Canal Winchester, Ohio
David Wheatley, London Truck and Tractor, London, Ohio

The following educator review panel was responsible for reviewing the integrated technical and academic competencies in the Environmental and Agricultural Career Cluster ITAC:

Monte R. Anderson, Wilmington College, Wilmington, Ohio
Katrina Baltic, Buckeye Career Center, New Philadelphia, Ohio
Richard Brill, Canal Winchester High School, Canal Winchester, Ohio
Wesley E. Budke, Ohio State University, Columbus, Ohio
Lisa L. Clevenger, Twin Valley South High School, W. Alexandria, Ohio
Tracy Dendinger, Miami Trace High School, Washington Court House, Ohio
Rich Fredrick, Sylvania Schools, Sylvania, Ohio
C. Eric (Rick) Metzger, Westfall High School, Williamsport, Ohio
Jesse R. Peters, Ansonia High School, Ansonia, Ohio
Andrew Wilson, Hardin Northern, Dola, Ohio



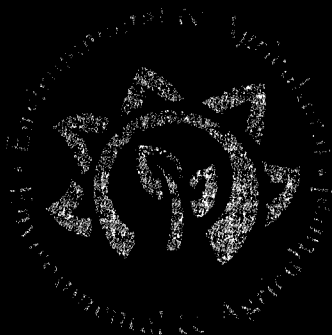

Ohio Department of Education
Division of Career-Technical and Adult Education



For more information and technical assistance contact the
Division of Career-Technical and Adult Education
65 South Front Street • Columbus, Ohio 43215
614-466-3430 • www.ode.ohio.gov





U.S. Department of Education
Office of Educational Research and Improvement (OERI)
National Library of Education (NLE)
Educational Resources Information Center (ERIC)



NOTICE

REPRODUCTION BASIS



This document is covered by a signed "Reproduction Release (Blanket) form (on file within the ERIC system), encompassing all or classes of documents from its source organization and, therefore, does not require a "Specific Document" Release form.



This document is Federally-funded, or carries its own permission to reproduce, or is otherwise in the public domain and, therefore, may be reproduced by ERIC without a signed Reproduction Release form (either "Specific Document" or "Blanket").